

Installation Instructions

Descriptions

The luminaire contains a constant-current driver and LED light sources. It works under technical conditions as the product labels indicate.

Technical Parameter

LED Street Light								
Type	N1		N2		N3		N4	
Power	60W		120W		180W		240W	
Input Voltage	<input type="checkbox"/> 100~240V	<input type="checkbox"/> 100~277V	<input type="checkbox"/> 220~240V	<input type="checkbox"/> 120~277V	<input type="checkbox"/> 277~480V	<input type="checkbox"/> Other ____	Frequency	50/60Hz
Power Factor	0.95							
Working Environment	-40°C~+50°C, 10%~90%RH							
Bolt Torque	17Nm							
Mounting Height	6~15m							
Mounting Spacing	20~45m							
Dimensions	540x240x165mm ^①	450x240x255mm ^②	670x240x165mm ^①	580x240x255mm ^②	735x310x165mm ^①	645x310x255mm ^②	835x310x165mm ^①	745x310x255mm ^②
Net Weight	4.1kg	4.1kg	4.8kg	4.8kg	6.1kg	6.1kg	7.0kg	7.0kg
Project Area	0.130m ²	0.108m ²	0.161m ²	0.140m ²	0.228m ²	0.199m ²	0.259m ²	0.231m ²
Degree of Protection	<input type="checkbox"/> IP54 <input type="checkbox"/> IP65 <input type="checkbox"/> IP66 <input type="checkbox"/> IP67 <input type="checkbox"/> Other ____							

Notes: The net weight above is typical value. The power above are maximum rated power of the model subject to tolerance of 10%.

① refers to dimensions of the side-entry-installation version.

② refers to dimensions of the post-top-installation version.

Applications

Expressways, highways, avenues, trunk roads, sub-trunk roads, paths, schools, residential areas, courtyards, etc.

Installation

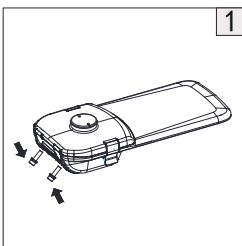

1. Undo the two M10 screws for the pole adaptor.

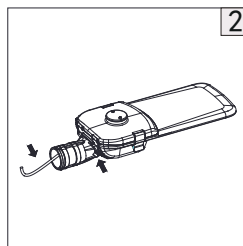

2. Thread the AC power supply cord through the pole adaptor into the driver box. Install the pole adaptor in post-top or side-entry way with proper tilt angle, and fixate it with the M10 screws.

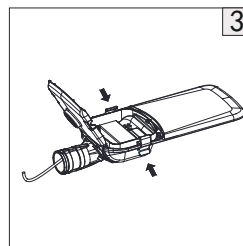

3. Undo the latches to open the cover upward.

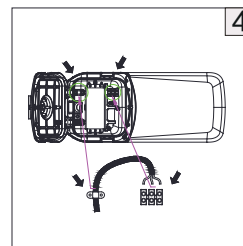

4. Do wiring on the terminal block at right position. Fixate the input cable with a clip.

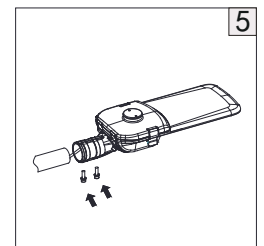

5. Close the cover and lock it with the latches. Mount the fixture onto the pole with screws fastened. Installation finished.

Elevation Angle Adjustment Instruction

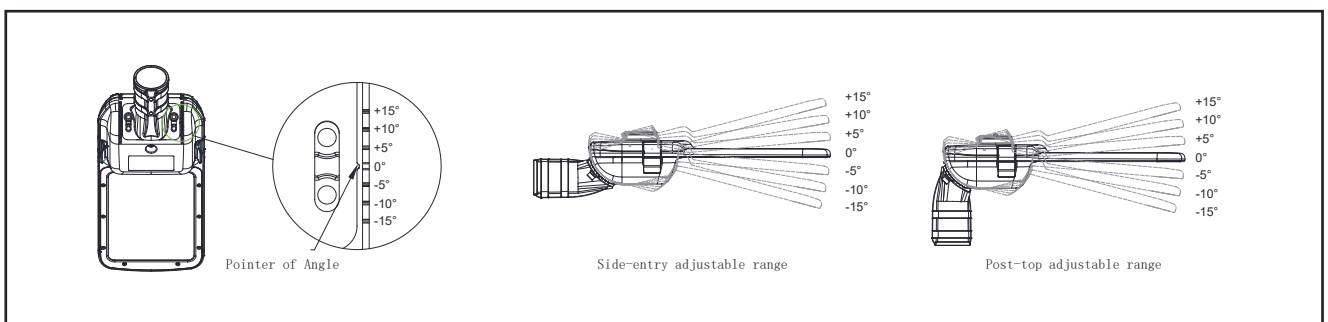

Installation Instructions

Installation of NEMA Receptacle and Photocell

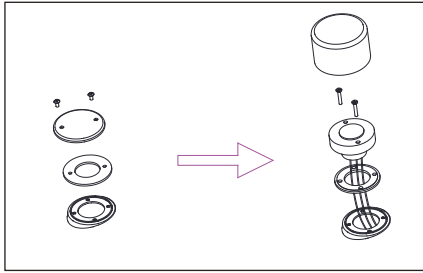

1. Undo the two screws to remove the round cover and its white sealing washer.
2. Thread the wires of the receptacle through the black sealing washer into the electrical compartment of luminaire. Keep the screw holes in alignment among the receptacle, sealing ring and luminaire, and fixate the receptacle with two M4x25 cross recessed countersunk head screws.
3. Plug in and fasten the photocell. Connect the wires in the electrical compartment.

Wiring

Power Supply End	Earth wire	Neutral wire	Live wire
Fixture End	Yellow-green lead	Blue lead	Brown lead
	Green lead	White lead	Black lead

Caution

- a** Disconnect or turn off power before installation, maintenance and wiring.
- b** Cable connection must be insulated and waterproof.
- c** The light source of this luminaire is not replaceable. When the light source's lifetime comes to an end, it is the whole luminaire that should be replaced.

Warning: Danger! Electric shock risk!

(via IEC 60417-6042 (2011-11))



This marking indicates that this product should not be disposed with other household wastes throughout the EU. To prevent possible harm to the environment or human health from uncontrolled waste disposal, recycle it responsibly to promote the sustainable reuse of material resources. To return your used device, please use the return and collection systems or contact the retailer where the product was purchased. They can take this product for environmental safe recycling

Remarks

1. This luminaire uses permanent connection on power supply with flexible cable and wires (60245 IEC57). Sufficient length of cable is reserved for connection to AC power. Protection over the connection joint and elimination of tensile force there should be ensured.
2. This luminaire uses type Y attachment: method of attachment of the cable or cord such that any replacement can only be made by the manufacturer, his service agent or similarly qualified person.
3. Wiring: the connection to AC power should be operated on terminal blocks in a wiring box with a degree of protection at least equivalent to the luminaire, and there should be devices to fixate wires.
4. The luminaire can be mounted onto ordinary combustible surfaces.