

# FL2C

## LED Flood Light





### Specifications

<b>Input Voltage:</b>	100 ~ 277Vac
<b>Input Frequency:</b>	50 / 60Hz
<b>Power Factor:</b>	0.95
<b>Surge Protection Level:</b>	10kV line-earth
<b>Working Environment:</b>	-40°C~ +45°C, 10% ~ 90% RH
<b>CCT:</b>	3000K, 4000K, 5000K, 5700K
<b>CRI:</b>	≥70
<b>Housing:</b>	Extrusion, Galvanized Steel
<b>IP Rating of LED Light Engine</b>	IP68
<b>IP Rating of LED Driver:</b>	IP67
<b>Impact Resistance</b>	IK09
<b>Warranty:</b>	5 Years Limited



### Finishing Colors

	Gray		Black
	White		Blue

### Features

#### Construction

- Whole structure heating dissipation design with efficient thermal conduction, radiation and convection.
- Unique patented IP68 LED light engines.
- Tool-less onsite replacement of light engines greatly reduces maintenance cost.

#### Electrical

- Flexible to reach desired power consumption up to 960W by choosing appropriate light engines.

#### Optical

- Ergonomic and specialized lighting distributions available for various area lighting.

### Applications

- Sports facilities (stadium, football field, golf course....)
- Traffic arteries (airport, crossroad....)
- Advertisement (wall, billboard....)

### Photos

FL2C-1/ 2/ 3/ 4/ 5/ 6/ 7/ 8



FL2C-10/ 12/ 14/ 16



# FL2C

LED Flood Light

## Ordering Information

Example: FL2C-4-240-M16B-BA-28-3160-7040-CM-MO-GY

Luminaire Type	Module Qty	System Power	LED Module	LED Package	Cable Standard	LED Qty per Module
FL Flood light	1 1 module	40 40W	M1A M1A module	A 3535	A CCC+VDE	18 18pcs
	2 2 modules	50 50W	M2A M2A module			
2C 2C series	.... ....	60 60W	M8B M8B module	C 3030	H UL	63 63pcs
	8 8 modules	..... ..	M16B M16B module			
	10 10 modules	300 300W		B 5050	X Others	18 18pcs
	12 12 modules	..... ..				
	14 14 modules	600 600W				
16 16 modules	..... ..	960 960W			28 28pcs	

Lens Code	CRI & CCT	Brand of LEDs	Driver Brand	Housing Color
1010 110degree	7030 Ra≥70, CCT 3000K	LU LUMILEDS	IN INVENTRONICS	BK Black
3040 Type Vs Short	7040 Ra≥70, CCT 4000K	CM LUMILEDS	MO MOSO	WH White
1908 12 degree	7050 Ra≥70, CCT 5000K	Customized	PH PHILIPS	BU Blue
3725 25 degree	7057 Ra≥70, CCT 5700K	SS SAMSUNG	MW MEAN WELL	GY Gray
3540 40 degree		NI NICHIA	AD ADAYO	
1325 25 degree		CR CREE	XX Others	
5340 40 degree		LN LUMINUS		
2360 60 degree		XX Others		
3125 25 degree				
3140 40 degree				
3160 60 degree				
2190 90 degree				
2211 90x40 degree				
2310 Lambertian type				
3504 80x40 degree				
3505 70x30 degree				

## Performance

Model	Power (W)	Module M1A/M2A-VA-18		Module M8B-VC-63		Module M16B-VB-18		Module M16B-VB-28	
		Efficacy (lm/W)	Flux (lm)	Efficacy (lm/W)	Flux (lm)	Efficacy (lm/W)	Flux (lm)	Efficacy (lm/W)	Flux (lm)
FL2C-1	40	130	5200	135	5400	152	6080	168	6720
	50	122	6100	130	6500	145	7250	163	8150
	60	117	7020	122	7320	133	7980	155	9300
FL2C-2	80	137	10960	140	11200	160	12800	175	14000
	100	130	13000	135	13500	150	15000	170	17000
	120	122	14640	127	15240	140	16800	163	19560
FL2C-3	120	137	16440	140	16800	160	19200	175	21000
	150	130	19500	135	20250	150	22500	170	25500
	180	122	21960	127	22860	140	25200	163	29340
FL2C-4	160	137	21920	140	22400	160	25600	175	28000
	200	130	26000	135	27000	150	30000	170	34000
	240	122	29280	127	30480	140	33600	163	39120
FL2C-5	200	137	27400	140	28000	160	32000	175	35000
	250	130	32500	135	33750	150	37500	170	42500
	300	122	36600	127	38100	140	42000	163	48900
FL2C-6	240	137	32880	140	33600	160	38400	175	42000
	300	130	39000	135	40500	150	45000	170	51000
	360	122	43920	127	45720	140	50400	163	58680
FL2C-7	280	137	38360	140	39200	160	44800	175	49000
	350	130	45500	135	47250	150	52500	170	59500
	420	122	51240	127	53340	140	58800	163	68460
FL2C-8	320	137	43840	140	44800	160	51200	175	56000
	400	130	52000	135	54000	150	60000	170	68000
	480	122	58560	127	60960	140	67200	163	78240

Notes: 1. Values shown are subject to ±5%~±8% tolerance. 2. Efficacy of Ra70 3000K is 5% lower than other CCT≥4000K.

# FL2C

LED Flood Light

## Performance

Model	Power (W)	Module M1A/M2A		Module M8B		Module M16B-VB-18		Module M16B-VB-28	
		Efficacy (lm/W)	Flux (lm)	Efficacy (lm/W)	Flux (lm)	Efficacy (lm/W)	Flux (lm)	Efficacy (lm/W)	Flux (lm)
FL2C-10	400	137	54800	140	56000	160	64000	175	70000
	500	130	65000	135	67500	150	75000	170	85000
	600	122	73200	127	76200	140	84000	163	97800
FL2C-12	480	137	65760	140	67200	160	76800	175	84000
	600	130	78000	135	81000	150	90000	170	102000
	720	122	87840	127	91440	140	100800	163	117360
FL2C-14	560	137	76720	140	78400	160	89600	175	98000
	700	130	91000	135	94500	150	105000	170	119000
	840	122	102480	127	106680	140	117600	163	136920
FL2C-16	640	137	87680	140	89600	160	102400	175	112000
	800	130	104000	135	108000	150	120000	170	136000
	960	122	117120	127	121920	140	134400	163	156480

Notes: 1. Values shown are subject to  $\pm 5\%$  tolerance. 2. Efficacy of Ra70 3000K is 5% lower than other CCT  $\geq 4000$ K.

## Product Dimensions

Model	L (mm)	W (mm)	H (mm)	N.W. (kg)
FL2C-1	95	360	200	3.6
FL2C-2	175	360	200	4.7
FL2C-3	255	360	260	6.0
FL2C-4	335	360	260	7.3
FL2C-5	415	360	360	9.5
FL2C-6	495	360	360	10.4
FL2C-7	575	360	360	11.9
FL2C-8	655	360	360	13.1
FL2C-10	415	680	395	28.9
FL2C-12	495	680	395	31.3
FL2C-14	575	680	395	34.3
FL2C-16	655	680	395	36.4

Notes: Typical values above. Actual N.W. is subject to tolerance of 5%.

### FL2C-1/ 2/ 3/ 4/ 5/ 6/ 7/ 8      FL2C-10/ 12/ 14/ 16

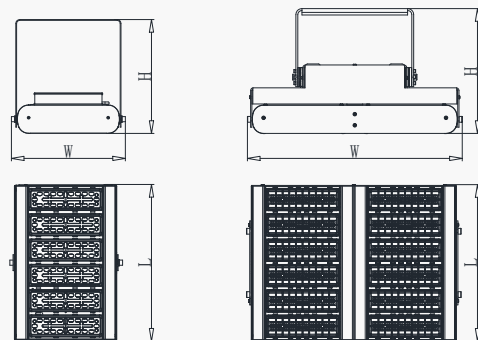

## Installation Bracket

### FL2C-1/ -2/ -3/ -4/ -5/ -6/ -7/ -8      FL2C-10/ -12/ -14/ -16

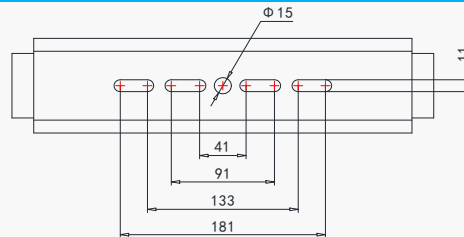
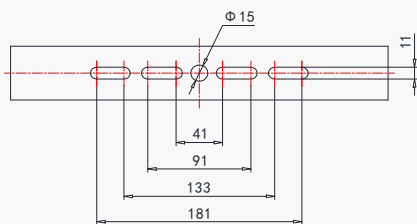

Notes: Unite: mm. Tolerance  $\pm 0.5$ mm.

## Installation Bracket

### FL2C-8      FL2C-10/ -12/ -14/ -16

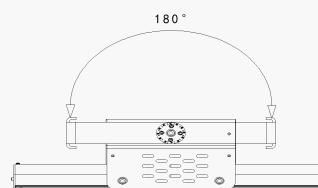
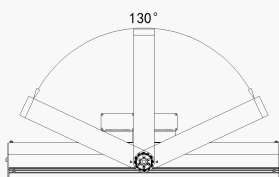

Notes: FL2C-1/ -2/ -3/ -4/ -5/ -6/ -7: adjustable in 360°.

# FL2C

LED Flood Light

## Package Information

Model	L (mm)	W (mm)	H (mm)	G.W. (kg)
FL2C-1	430	265	150	4.1
FL2C-2	430	265	230	5.4
FL2C-3	430	335	330	7.0
FL2C-4	475	430	210	8.5
FL2C-5	615	430	240	11.0
FL2C-6	660	430	240	12.0
FL2C-7	695	430	240	13.5
FL2C-8	785	430	260	14.8
FL2C-10	770	510	335	31.9
FL2C-12	770	590	335	34.8
FL2C-14	770	670	335	38.2
FL2C-16	770	750	335	40.7

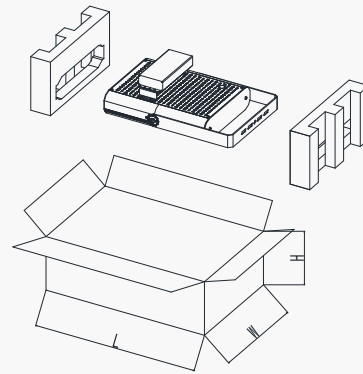

Notes: Typical values above. Tolerance of dimensions:  $\pm 5\text{mm}$ . Tolerance of G.W.: 5%.

## Typical Distributions

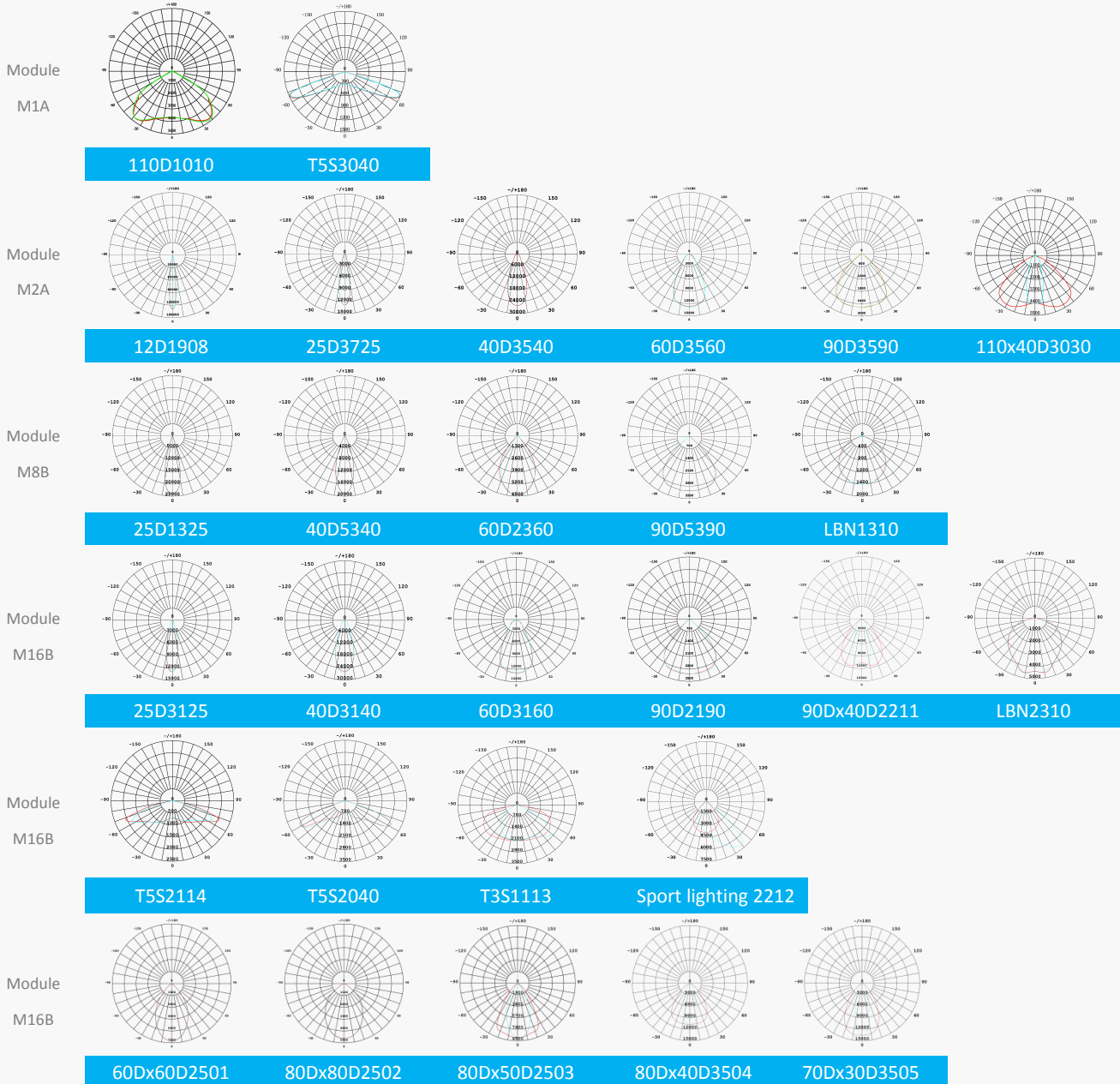

# FL2C

LED Flood Light

## Version History

Change Date	Version	Item	Description of Change	
			From	To
2016/06/01	Rev1.0	Datasheets Release	/	/
2016/08/20	Rev1.1	M16B	/	Added
2018/04/08	Rev1.2	Working Environment & Storage Temperature	-40°C~+50°C	-40°C~+45°C
2018/08/31	Rev1.3	Lighting distributions		Added
2019/02/26	Ver. 2.0	New format. Efficacy increase with M1A/M2A and M8B.	/	/
2019/04/17	Ver. 2.1	Photo of FL2C-10~16		Added
2019/07/15	Ver. 2.2	Package information of FL2C-1~8 Company logo Efficacy increase with M16B	/	/