

TS2C



LED Tunnel Light



Specifications

Input Voltage:	100 ~ 277Vac
Input Frequency:	50 / 60Hz
Power Factor:	0.95
Surge Protection Level:	10kV line-earth
Working Environment:	-40°C ~ +50°C, 10% ~ 90% RH
CCT:	3000K, 4000K, 5000K, 5700K
CRI:	≥70
Housing:	Extrusion
IP Rating of LED Engine:	IP68
IP Rating of LED Driver:	IP67
Warranty:	5 Years Limited

Finishing Colors

	Gray		Black
	White		Blue

Applications

- Tunnel lighting (tunnel, underpass, corridor....)



Features

Construction

- Whole structure heating dissipation design with efficient thermal conduction, radiation and convection.
- Unique patented IP68 LED light engines.
- Tool-less onsite replacement of light engines greatly reduces maintenance cost.

Electrical

- Flexible to reach desired power consumption by choosing appropriate light engines.

Optical

- Ergonomic and specialized lighting distributions.

Mounting

- Bracket adjustable within ±180° maximum.

Photos

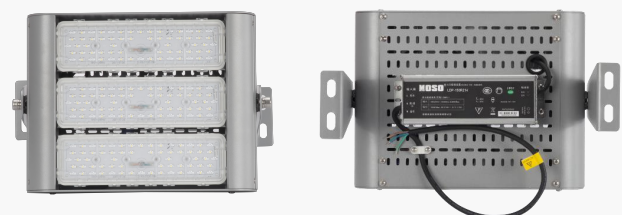

TS2C

LED Tunnel Light

Ordering Information

Example: TS2C-3-180-M8B-CA-63-1390-7040-LU-MO-GY

Luminaire Type	Module Qty	System Power	LED Module	LED Package	Cable Standard	LED Qty per Module
TS Tunnel light	1 1 module	40 40W	M1A M1A module	A 3535	A CCC+VDE	18 18pcs
	2 2modules	50 50W	M2A M2A module			
2C 2C series	60 60W	M8B M8B module	C 3030	H UL X Others	63 63pcs
	6 6 modules	M16B M16B module			
	7 7 modules	420 420W		B 5050		18 18pcs 28 28pcs

Lens Code	CRI & CCT	Brand of LEDs	Driver Brand	Housing Color
1501 Type I Short	1010 110degree	7030 Ra≥70, CCT 3000K	LU LUMILEDS	MO MOSO
3501 Type I Short	3010 Tunnel lighting	7040 Ra≥70, CCT 4000K	CM LUMILEDS	IN INVENTRONICS
3100 Type I Short		7050 Ra≥70, CCT 5000K	Customized	PH PHILIPS
3590 90 degree		7057 Ra≥70, CCT 5700K	SS SAMSUNG	MW MEAN WELL
2321 Type II Short	1310 Lambertian type		NI NICHIA	XX Others
1324 Type II Short	1390 Tunnel lighting		CR CREE	
5390 90 degree			LN LUMINUS	
1107 Type I Short	2310 Lambertian type		XX Others	BK Black
2105 Type II Short	2123 Tunnel lighting			WH White
2190 90 degree				BU Blue
				GY Gray

Performance

Model	Power (W)	Module M1A/M2A-VA-18		Module M8B-VC-63		Module M16B-VB-18		Module M16B-VB-28	
		Efficacy (lm/W)	Flux (lm)	Efficacy (lm/W)	Flux (lm)	Efficacy (lm/W)	Flux (lm)	Efficacy (lm/W)	Flux (lm)
TS2C-1	40	130	5200	135	5400	152	6080	168	6720
	50	122	6100	130	6500	145	7250	163	8150
	60	117	7020	122	7320	133	7980	155	9300
TS2C-2	80	137	10960	140	11200	160	12800	175	14000
	100	130	13000	135	13500	150	15000	170	17000
	120	122	14640	127	15240	140	16800	163	19560
TS2C-3	120	137	16440	140	16800	160	19200	175	21000
	150	130	19500	135	20250	150	22500	170	25500
	180	122	21960	127	22860	140	25200	163	29340
TS2C-4	160	137	21920	140	22400	160	25600	175	28000
	200	130	26000	135	27000	150	30000	170	34000
	240	122	29280	127	30480	140	33600	163	39120
TS2C-5	200	137	27400	140	28000	160	32000	175	35000
	250	130	32500	135	33750	150	37500	170	42500
	300	122	36600	127	38100	140	42000	163	48900
TS2C-6	240	137	32880	140	33600	160	38400	175	42000
	300	130	39000	135	40500	150	45000	170	51000
	360	122	43920	127	45720	140	50400	163	58680
TS2C-7	280	137	38360	140	39200	160	44800	175	49000
	350	130	45500	135	47250	150	52500	170	59500
	420	122	51240	127	53340	140	58800	163	68460

Note: 1. Values shown are subject to ±5%~±8% tolerance.

2. Efficacy of Ra70 3000K is 5% lower than other CCT≥4000K.

TS2C

LED Tunnel Light

Product Dimensions

Model	L (mm)	W (mm)	H (mm)	N.W. (kg)
TS2C-1	95	390	220	3.3
TS2C-2	175	390	220	4.8
TS2C-3	255	390	220	5.6
TS2C-4	335	390	220	6.7
TS2C-5	415	390	280	8.4
TS2C-6	495	390	280	9.4
TS2C-7	575	390	280	10.5

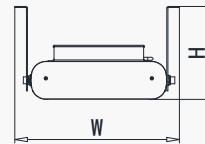
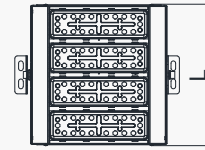

Notes: Typical values above. Actual N.W. is subject to tolerance of 5%. Dimension tolerance: $\pm 5\text{mm}$

Package Information

Model	L (mm)	W (mm)	H (mm)	G.W. (kg)
TS2C-1	285	430	150	4.2
TS2C-2	285	430	230	5.8
TS2C-3	355	430	290	6.7
TS2C-4	425	430	210	8.0
TS2C-5	535	430	240	9.9
TS2C-6	585	430	240	11.0
TS2C-7	660	430	240	12.2

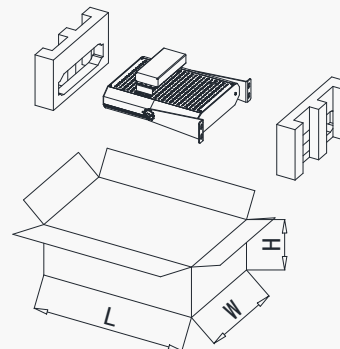

Notes: Typical values above. Tolerance of dimensions: $\pm 5\text{mm}$. Tolerance of G.W.: 5%.

Mounting Holes Dimensions

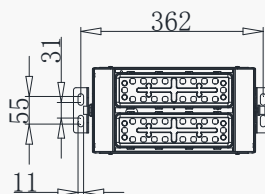

TS2C-1/ -2/ -3/ -4/ -5/ -6/ -7

Notes: Unite: mm. Tolerance $\pm 0.5\text{mm}$. Same dimensions for all models. Take the drawing of TS2C-2 as reference.

TS2C

LED Tunnel Light

Bracket Tilt

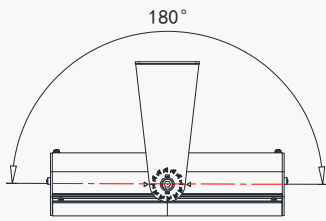

TS2C-1/ -2/ -3/ -4/ -5

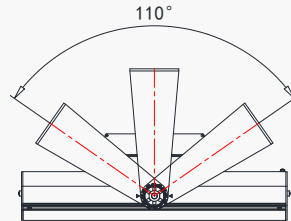

TS2C-6

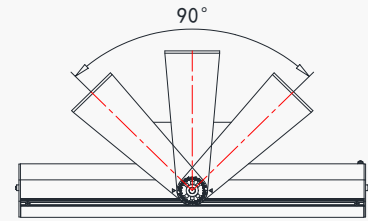

TS2C-7

Mounting Direction Instructions

1. If there are arrows like below found on the fixture, follow the direction of its arrow in the middle as pointing to the center of the roadway instead of borders.

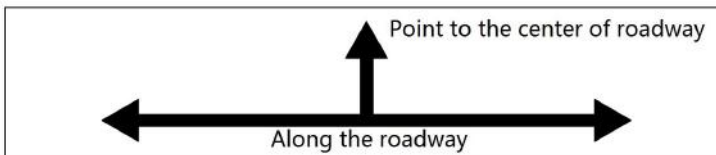

2. If there is no figure of arrows like above found on the fixture, check arrows on LED module lenses.

2.1. When there is only one arrow direction on the lens, follow the direction of arrows as pointing to the center of roadway instead of borders.

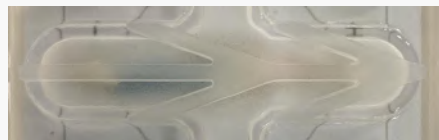
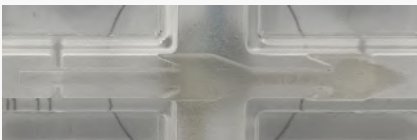

2.2. When there are opposite arrows on the lens, follow the direction as arrows being along the roadway.

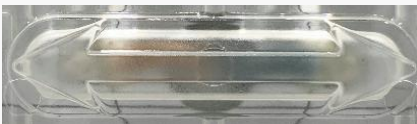

3. If there is no figure of arrow on LED module lens, it is a symmetric lighting distribution solution. No particular direction. Only adjust the brackets.

Optional Accessories



Driver Cover

TS2C

LED Tunnel Light

Typical Distributions

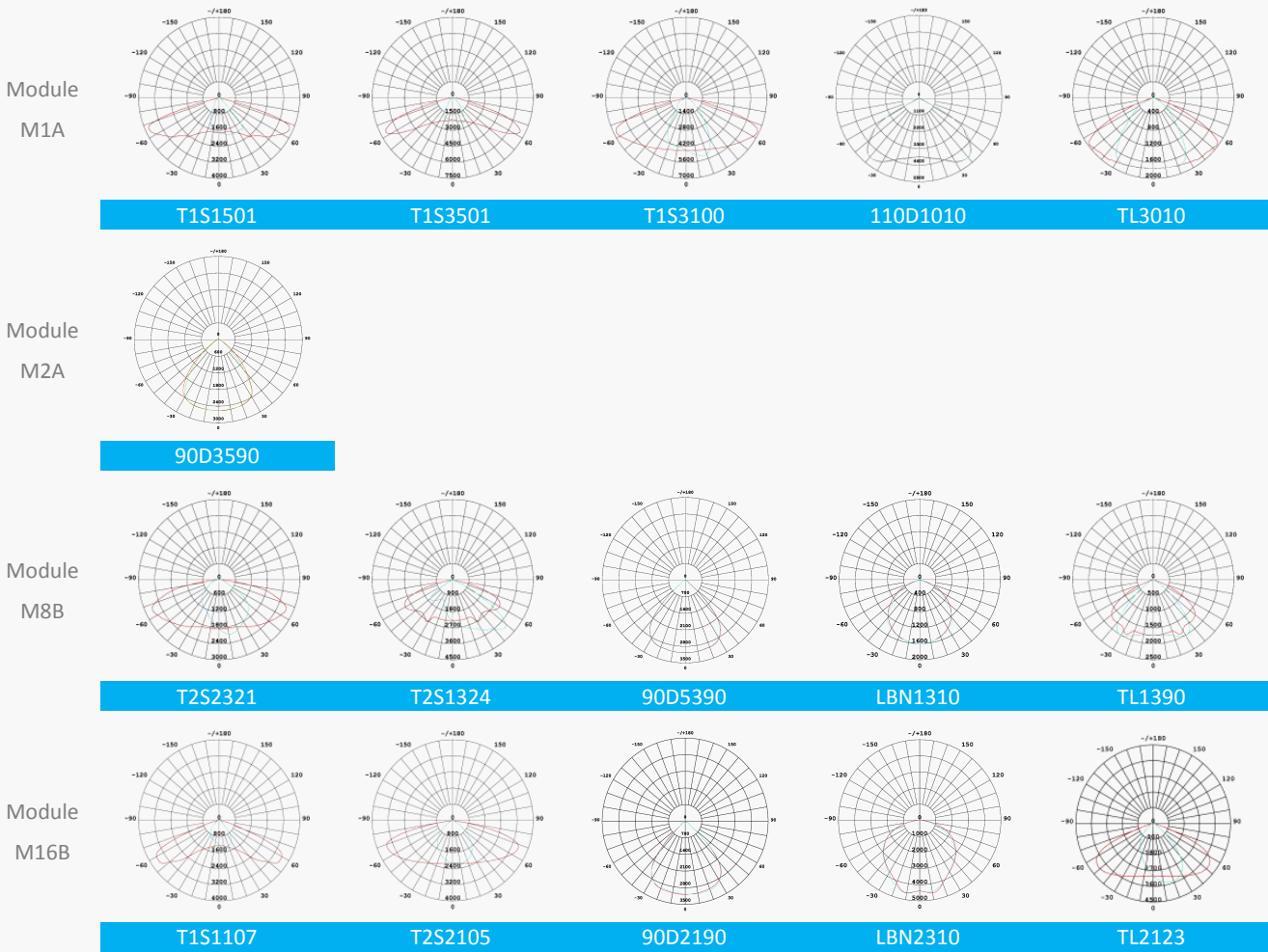

Version History

Change Date	Version	Item	Description of Change	
			From	To
2019/10/18	Ver3.0	Datasheet in new format Efficacy improved	/	/
2019/10/25	Ver3.1	Mounting Direction Instructions		added