

HPWINNER



HANGZHOU HPWINNER OPTO CORPORATION

HQ Add: 3F, Building F, Intelligence & Information Industry Park, No.108 Xiangyuan Road, Gongshu District, Hangzhou, Zhejiang, China
Factory Add: No.9, Baixi Avenue, Changxing Economic Development Zone, Huzhou, Zhejiang, China
Contact: sales@hpwin.com Tel: +86-571-88061966 Fax: +86-571-89971205

All copyrights related to the manual shall be reserved by Hangzhou Hpwinner Opto Corporation.
And it is prohibited to fully or partially copy this manual without written consent of Hangzhou Hpwinner Opto Corporation.

2024.05



HANGZHOU HPWINNER OPTO CORPORATION

CONTENTS

- 03 ABOUT US
- 05 R&D ADVANTAGES
- 06 MANUFACTURE ADVANTAGES
- 07 TECHNICAL ADVANTAGES
- 08 MANAGEMENT SYSTEM CERTIFICATION
- 09 TYPICAL CASES
- 10 OVERVIEW OF HIGH-POWER APPLICATION SERIES
- 11 LED MODULES
- 15 LED STREET LIGHT
- 27 LED GARDEN LIGHT
- 29 TUNNEL LIGHT
- 31 LED HIGH BAY LIGHT
- 33 LED FLOOD LIGHT
- 35 LED STADIUM LIGHT
- 36 LED AIRPORT LIGHT
- 37 KEY PART SOLUTION
- 39 LIGHTING DISTRIBUTION
- 46 ORDERING INFORMATION



928

Patents Applied

627

Patents Obtained

62

Patents Invention



ABOUT US

Hangzhou HPWINNER Opto Corporation is committed to becoming a global leader for low-carbon solutions in the field of roadway lighting.

HPWINNER was established in July, 2011. The founders were Doctors and Masters graduated from the Institute of Optics and Electronics of the Chinese Academy of Sciences and College of Optical Science and Engineering of Zhejiang University, with strong scientific research capabilities and R&D system background.

Since its establishment, it has produced numerous LED street lights that could encircle the earth's equator by nearly 5 times in usual methods of installation.

The company owns a well-equipped LED roadway lighting product system, and has a worldwide sales network. With distribution more than 10 overseas branches and offices, the annual shipment of more than 2 million sets of LED luminaires were sold and shipped to around 100 countries and regions. In China, HPWINNER products are installed in almost every province and provincial capitals. It has offered the best products and services to over 9,000 customers all over the world.

HPWINNER is one of the leading enterprises in LED roadway lighting industry, specializing in brand, research and development, design, production, marketing, and services. The company's laboratory has obtained CNAS, UL, SGS, NVLAP, TUV, DEKRA and other domestic and foreign authoritative certification.

The company has built a large intelligent manufacturing base. Relying on the digital platform, through the engineering site, product configuration scheme, order data, planning and scheduling, manufacturing site, supply chain, product delivery and other links, HPWINNER to achieve quick response and provide customized products and services.

www.hpwinner.com

INTELLIGENT MANUFACTURE

In April 2018, this manufacturing base put into operation officially, covering an area **96** acres and built-up area of **50000** square meters. It consists of 3 standardized industrial plants and auxiliary rooms, including SMT and module workshop, assembly workshop, storage and logistics center.

SMT WORKSHOP

5 imported SMT production lines

4 LED module production lines

Daily production capacity: **30000** LED modules



ASSEMBLY WORKSHOP

Adopting the Lean Manufacturing Principle

10 finished luminaires assembly Line

15000 luminaires daily production capacity



R&D ADVANTAGES



MANUFACTURE ADVANTAGES

-  MASS CUSTOMIZATION
-  FAST RESPONSE
-  HIGH QUALITY
-  ONE-STOP SERVICES
-  INDUSTRIAL INTERNET



TECHNICAL ADVANTAGES

5050 HIGH POWER COMPONENT

In 2016, the 5050 components successful products jointly developed by HPWINNER, LUMILEDS and SANAN. It has become the mainstream component of high luminous efficacy in LED roadway light. Compared with traditional 3535 package, its luminous efficacy has improved by 30%.

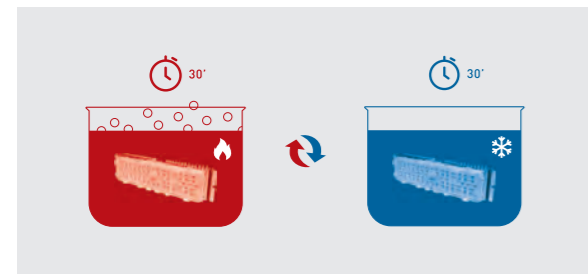
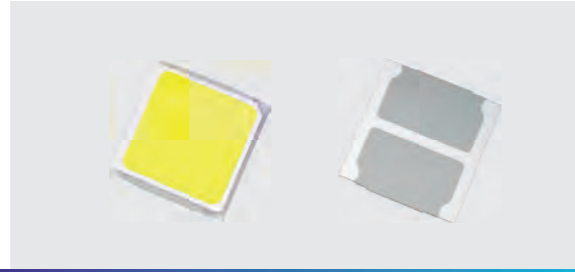

DOUBLE-COUPLING IP68 PROTECTION

It adopts the screw-free structure to avoid the penetration of water vapor through the screw hole, and its double silicon rubber rings insulate the LED chip from the outside environment completely, thus protecting inner LED components and PCB from any corrosion caused by water vapor or other noxious gases.

ERGONOMIC LIGHT DISTRIBUTION

The products adopt equal-brightness optical design in full consideration that it is unavailable to detect illumination by eyes because human eyes are sensitive to brightness, thus not only eliminating the visual bright spots and dark spots on the road surface, but also bringing visual ease and comfort to road operators, as well as improving lighting illumination and obtaining accurate detected values.



INTELLIGENT LIGHTING

Modular intelligent components with different functions can work in free combination on a modular intelligent street light to meet different purposes.

FREE SERIALIZATION

It is available to freely equip with different numbers of modules to achieve different powers as required.



MANAGEMENT SYSTEM CERTIFICATION



TYPICAL CASES

FULL COVERAGE OF OUTDOOR LIGHTING APPLICATIONS



OVERVIEW OF HIGH-POWER APPLICATION SERIES

LED high-power applications, namely semiconductor lighting products, adopt LED as lighting source, and feature environmental protection, low power consumption, high luminous efficiency, as well as long life span. The LED high-power applications independently developed by HPWINNER include LED street lights, LED tunnel lights, LED high bay lights, and LED flood lights series.

LED Modules



**M66A
-VC/CC LED MODULE**



M66A-VC

M16A-CC

CE RoHS IP68 IK09 Ra ≥70 5 YEAR WARRANTY

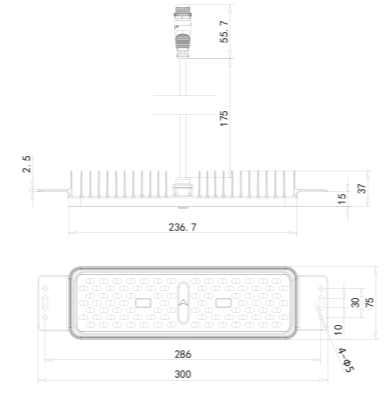
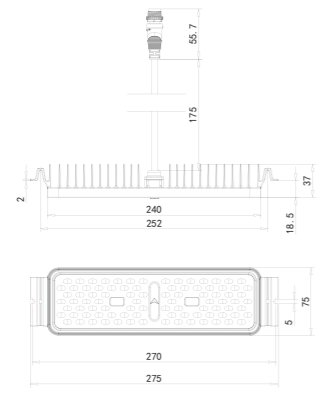

TECHNICAL PARAMETERS

Input Voltage	48-61Vdc		
Drive Current	700mA	860mA	1050mA
Typical System Power ^[1]	40W	50W	60W Maximum
Typical Luminous Efficacy ^[2]	160lm/W	155lm/W	150lm/W
Typical Luminous Flux	6400lm	7750lm	9000lm
Nominal CCT	3000K/ 4000K/ 5000/ 5700K		
Lighting Distribution	Type II/ III 25°/40°/60°/90°		
IP Rating	IP68		
Working Environment	-40°C~+50°C, 10%-90%RH		
LED Quantity	Lumileds Luxeon 3030x90pcs		
Dimensions	275*75*37mm		
Net Weight	0.58kg		

**M66A
-VB/CB LED MODULE**



M66A-VB

M66A-CB

CE RoHS IP68 IK09 Ra ≥70 5 YEAR WARRANTY

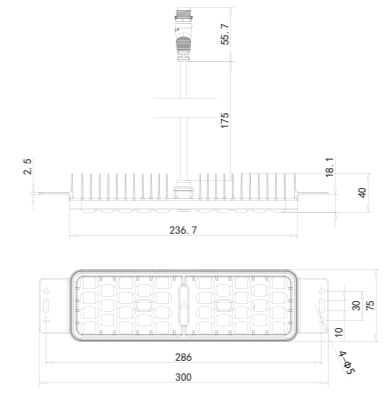
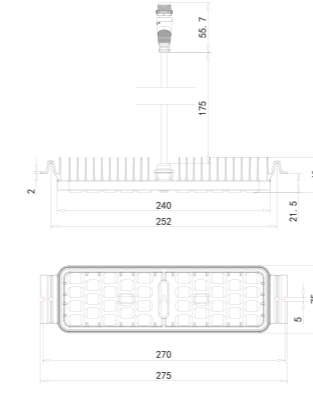

TECHNICAL PARAMETERS

Input Voltage	50-64Vdc		
Drive Current	700mA	860mA	1000mA
Typical System Power ^[1]	40W	50W	60W Maximum
Typical Luminous Efficacy ^[2]	185lm/W	182lm/W	178lm/W
Typical Luminous Flux	7400lm	9100lm	10680lm
Nominal CCT	3000K/ 4000K/ 5000/ 5700K		
Lighting Distribution	Type I/II/III 25°/40°/60°/90°		
IP Rating	IP68		
Working Environment	-40°C~+50°C, 10%-90%RH		
LED Quantity	HPW5050x34pcs		
Dimensions	275*75*42mm		
Net Weight	0.58kg		

**M16A
-VB
LED MODULE**



M16A-VB-28

M16A-VB-34

CE CB RoHS IP68 IK09 Ra ≥ 70

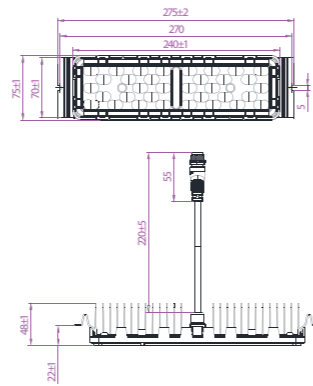
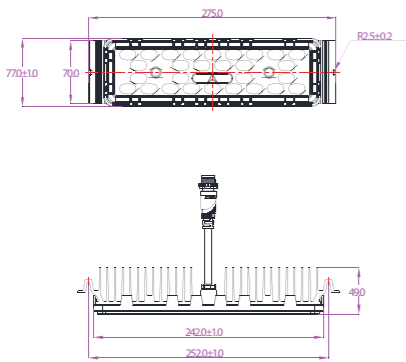

TECHNICAL PARAMETERS

M16A-28			M16A-34				
Input Voltage	40-54Vdc		Input Voltage	50-64Vdc			
Drive Current	800mA	1000mA	1200mA	Drive Current	700mA	850mA	1000mA
Typical System Power ^[1]	40W	50W	60W Maximum	Typical System Power ^[1]	40W	50W	60W Maximum
Typical Luminous Efficacy ^[2]	175lm/W	170lm/W	163lm/W	Typical Luminous Efficacy ^[2]	190lm/W	185lm/W	180lm/W
Typical Luminous Flux	7000lm	8500lm	9780lm	Typical Luminous Flux	7600lm	9250lm	10800lm
Nominal CCT	3000K/ 4000K/ 5000/ 5700K			Nominal CCT	3000k/4000k/5000k/5700k		
Lighting Distribution	Type I/II/III/V, Tunnel/Sport lighting, 25°/40°/60°/90°			Lighting Distribution	Type I II		
IP Rating	IP68			IP Rating	IP68		
Working Environment	-40°C~+50°C, 10%-90%RH			Working Environment	-40°C~+50°C, 10%-90%RH		
LED Quantity	Customized Lumileds 5050x28pcs			LED Quantity	HPW5050x34pcs		
Dimensions	275*75*48mm			Dimensions	275*75*48mm		
Net Weight	0.52kg			Net Weight	0.52kg		

**M16A
-VC
LED MODULE**



CE CB RoHS IP68 IK09 Ra ≥ 70

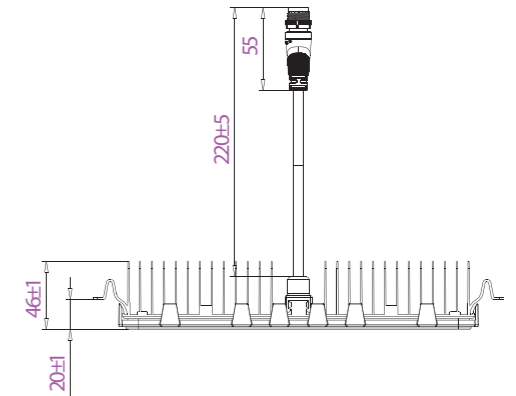
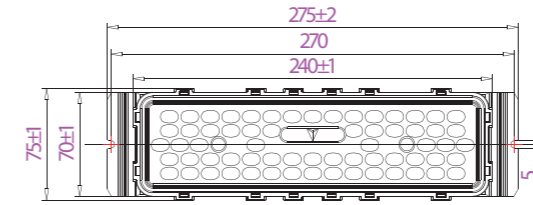

TECHNICAL PARAMETERS

Input Voltage	48-61Vdc		
Drive Current	700mA	860mA	1050mA
Typical System Power ^[1]	40W	50W	60W Maximum
Typical Luminous Efficacy ^[2]	145lm/W	140lm/W	130lm/W
Typical Luminous Flux	5800lm	7000lm	7800lm
Nominal CCT	3000K/ 4000K/ 5000/ 5700K		
Lighting Distribution	Type I/II/III, 25°/40°/60°/90°/Lambertian		
IP Rating	IP68		
Working Environment	-40°C~+50°C, 10%-90%RH		
LED Quantity	Lumileds Luxeon 3030x63pcs		
Dimensions	275*75*46mm		
Net Weight	0.52kg		

T11A LED STREET LIGHT



MAIN FEATURES

- Unique patented IP68 LED light engines;
- Ergonomic and dedicated lighting distributions are available for various roadway applications;
- Whole structure heating dissipation design with excellent thermal conduction, radiation and convection;
- Flexible to reach desired power selections by choosing appropriate light engines;
- Tool-free onsite replacements of light engines greatly reduce maintenance cost;
- Unmatched lighting performance, driver stability and desirable lifespan.

CE CB RoHS



TECHNICAL PARAMETERS

Input Voltage	100-277Vac						
Power Factor	0.95						
Available CCT	3000K/4000K/5000K/5700K						
Module Type	M16A-VC			M16A-VB			
LED Brand	Lumileds Luxeon 3030			Customized Lumileds 5050			
Module Picture							
Module Quantity	1	2	3	4	5	6	7
Power	40W 50W 60W	80W 100W 120W	120W 150W 180W	160W 200W 240W	200W 250W 300W	240W 300W 360W	280W 350W 420W
Typical Luminous Efficacy	140lm/W @40W/Engine 135lm/W @50W/Engine 127lm/W @60W/Engine			175lm/W @40W/Engine 170lm/W @50W/Engine 163lm/W @60W/Engine			
Lighting Distribution	TYPE I TYPE II TYPE III TYPE V See lighting distribution options on appendix						
Working Temperature	-40~+50°C						
Installation Diameter	Ø57-63mm						

T19E LED STREET LIGHT



MAIN FEATURES

- Unique patented IP68 LED light engines;
- Ergonomic and dedicated lighting distributions available for various roadway applications;
- Whole structure heating dissipation design with excellent thermal conduction, radiation and convection;
- Flexible to reach desired power selections by choosing appropriate light engines;
- Tool-free onsite replacements of light engines greatly reduce maintenance cost;
- Unmatched lighting performance, driver stability and desirable lifespan;
- IP66 rated electrical compartment;
- Die-cast latches provide easy, tool-less access to the electrical compartment;
- Post-top & side-entry with ±15° inclination in steps of 5°;
- Optional NEMA receptacle & photocell.

CE CB RoHS

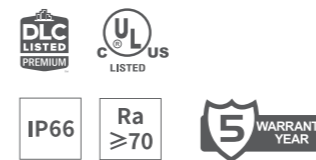

TECHNICAL PARAMETERS

Input Voltage	100-277Vac						
Power Factor	0.95						
Available CCT	3000K/4000K/5000K/5700K						
Module Type	M16A-VC			M16A-VB			
LED Brand	Lumileds Luxeon 3030			Customized Lumileds 5050			
Module Picture							
Module Quantity	1	2	3	4	5	6	7
Power	40W 50W 60W	80W 100W 120W	120W 150W 180W	160W 200W 240W	200W 250W 300W	240W 300W 360W	280W 350W 420W
Typical Luminous Efficacy	140lm/W @40W/Engine 135lm/W @50W/Engine 127lm/W @60W/Engine			175lm/W @40W/Engine 170lm/W @50W/Engine 163lm/W @60W/Engine			
Lighting Distribution	TYPE I TYPE II TYPE III TYPE V See lighting distribution options on appendix						
Working Temperature	-40~+50°C						
Installation Diameter	Ø40-50mm/Ø55-65mm/Ø65-75mm						

T88 LED STREET LIGHT

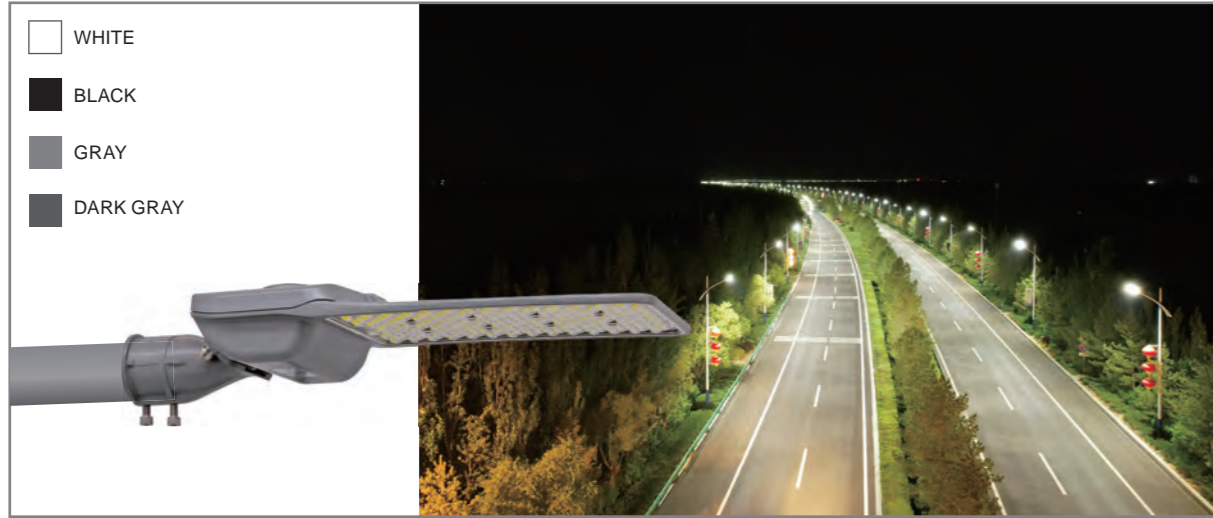

CE CB RoHS



■ MAIN FEATURES

- Unique patented IP68 LED light engines;
- Tool-less access to IP66 rated electrical compartment;
- Die-cast aluminum housing, solid mechanism and reliable quality;
- Ergonomic and dedicated lighting distributions for unmatched lighting performance;
- Fin-less whole structure heating dissipation design;
- Post-top or side-entry installation with +15°inclination;
- Optional NEMA receptacle & photocell for energy-saving.

■ TECHNICAL PARAMETERS

Input Voltage	100-240Vac		
Power	30W-150W		
Power Factor	0.95		
Available CCT	3000K/4000K/5000K/5700K		
LED Brand	HPW5050		
Typical Luminous Efficacy	T88S	T88M	T88L
	179lm/W @30W 189lm/W @60W	189lm/W @100W	194lm/W @150W
Lighting Distribution	TYPE I	TYPE II	TYPE III
	See lighting distribution options on appendix		
Working Temperature	-40~+50°C		
Installation Diameter	Ø57-63mm		

T1 MAX LED STREET LIGHT



CE CB RoHS



■ MAIN FEATURES

- Unique patented IP68 LED light engines;
- Die-cast aluminum housing, solid mechanism and reliable quality;
- Class II by default, Class I by option;
- Ergonomic and dedicated lighting distributions for roadway applications;
- Unmatched lighting performance, driver stability and desirable lifespan;
- Whole structure heating dissipation with excellent thermal conduction and radiation;
- Sensor available (on/off);
- Available for mast-arm of both Ø60mm & Ø40mm.

■ TECHNICAL PARAMETERS

Input Voltage	100-277Vac
Power	20W/30W/40W
Power Factor	0.95
Available CCT	3000K/4000K/5000K/5700K
LED Brand	HPW5050
Typical Luminous Efficacy	185lm/W @20W
	185lm/W @30W
	180lm/W @40W
Lighting Distribution	TYPE I
	See lighting distribution options on appendix
Working Temperature	-40~+50°C
Installation Diameter	Ø40-45mm/Ø57-63mm

**T1Q
MAX** LED STREET LIGHT

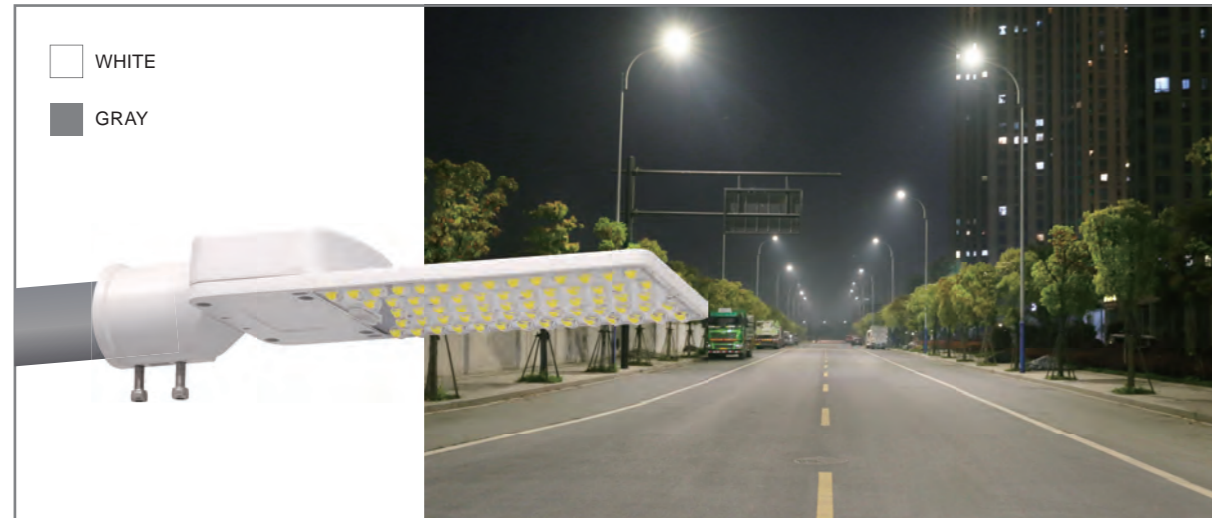

**T2Q
MAX** LED STREET LIGHT



CE CB RoHS



■ MAIN FEATURES

- Unique patented IP68 LED light engines;
- Die-cast aluminum housing, solid mechanism and reliable quality;
- Class II by default, Class I by option;
- Ergonomic and dedicated lighting distributions for roadway applications;
- Unmatched lighting performance, driver stability and desirable lifespan;
- Whole structure heating dissipation with excellent thermal conduction and radiation;
- Sensor available (on/off);
- Available for mast-arm of both Ø60mm & Ø40mm.

■ TECHNICAL PARAMETERS

Input Voltage	100-277Vac
Power	40W/50W/60W
Power Factor	0.95
Available CCT	3000K/4000K/5000K/5700K
LED Brand	HPW5050
Typical Luminous Efficacy	190lm/W @40W 188lm/W @50W 185lm/W @60W
Lighting Distribution	TYPE III See lighting distribution options on appendix
Working Temperature	-40~+50°C
Installation Diameter	Ø57-63mm/Ø40-45mm

CE CB RoHS



■ MAIN FEATURES

- Unique patented IP68 LED light engines;
- Die-cast aluminum housing, solid mechanism and reliable quality;
- Class II by default, Class I by option;
- Ergonomic and dedicated lighting distributions for roadway applications;
- Unmatched lighting performance, driver stability and desirable lifespan;
- Whole structure heating dissipation with excellent thermal conduction and radiation;
- Sensor available (on/off);
- Available for mast-arm of both Ø60mm & Ø40mm.

■ TECHNICAL PARAMETERS

Input Voltage	100-277Vac
Power	80W/90W/100W
Power Factor	0.95
Available CCT	3000K/4000K/5000K/5700K
LED Brand	HPW5050
Typical Luminous Efficacy	190lm/W @80W 188lm/W @90W 185lm/W @100W
Lighting Distribution	TYPE III See lighting distribution options on appendix
Working Temperature	-40~+50°C
Installation Diameter	Ø57-63mm/Ø40-45mm

T29 LED STREET LIGHT



MAIN FEATURES

- Unique patented IP68 LED light engines;
- Ergonomic and dedicated lighting distributions available for roadway applications;
- Whole structure heating dissipation design with excellent thermal conduction and radiation;
- Unmatched lighting performance, driver stability and desirable lifespan;
- IP66 rated electrical compartment;
- Optional NEMA receptacle & photocell.

CE CB RoHS

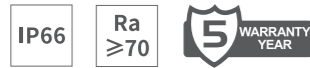

TECHNICAL PARAMETERS

Input Voltage	100-277Vac			
Power	20W-120W			
Power Factor	0.95			
Available CCT	3000K/4000K/5000K/5700K			
LED Brand	Lumileds Luxeon 3030		Customized Lumileds 5050	
Typical Luminous Efficacy	T29A	—		145lm/W @20W 140lm/W @30W 130lm/W @40W
	T29B	135lm/W @40W 130lm/W @50W 122lm/W @60W	163lm/W @40W 157lm/W @50W 150lm/W @60W	
	T29C	140lm/W @40W/Engine 135lm/W @50W/Engine 127lm/W @60W/Engine	175lm/W @80W 170lm/W @100W 163lm/W @120W	
Lighting Distribution	TYPE I TYPE II TYPE III TYPE V See lighting distribution options on appendix			
Working Temperature	-40~+50°C			
Installation Diameter	Ø50-60mm			

Notes: Tolerance of luminous efficacy value: ±5%~±8%. Efficacy of CCT 3000K is lower than above by 5%.

T33 LED STREET LIGHT



MAIN FEATURES

- Die-cast aluminum housing, solid mechanism and reliable quality;
- Unique patented IP68 LED light engines protect LEDs from water vapor and hazardous gases;
- IP66 rated electrical compartment;
- Ergonomic and dedicated lighting distributions are available for various roadway applications;
- Whole structure heating dissipation design;
- Optional NEMA receptacle & photocell.

CE CB RoHS



TECHNICAL PARAMETERS

Input Voltage	100-277Vac			
Power	40W-240W			
Power Factor	0.95			
Available CCT	3000K/4000K/5000K/5700K			
LED Brand	Lumileds Luxeon 3030		Customized Lumileds 5050	
Typical Luminous Efficacy	T33A	135lm/W @40W 130lm/W @50W 122lm/W @60W	150lm/W @40W 145lm/W @50W 140lm/W @60W	
	T33B	138lm/W @80W 134lm/W @90W 129m/W @100W	158lm/W @80W 155lm/W @90W 152lm/W @100W	
	T33C/D/E	140lm/W @40W/Engine 135lm/W @50W/Engine 127lm/W @60W/Engine	175lm/W @40W/Engine 170lm/W @50W/Engine 163lm/W @60W/Engine	
Lighting Distribution	TYPE I TYPE II TYPE III TYPE V See lighting distribution options on appendix			
Working Temperature	T33A/B/C: -40°C~+50°C; T33D/E: -40°C~+45°C			
Installation Diameter	Ø57-63mm			

T65

LED STREET LIGHT



CE CB RoHS

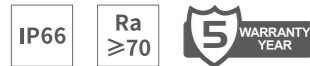

MAIN FEATURES

- Unique patented IP68 LED light engines;
- Two latches provide easy, tool-less access to the IP66 rated electrical compartment;
- Die-cast aluminum housing, solid mechanism and reliable quality;
- Ergonomic and dedicated lighting distributions for unmatched lighting performance;
- Fin-less whole structure heating dissipation design;
- Tempered glass for easy cleaning;
- Post-top or side-entry installation with ±15° inclination, compatible with a wide range of pole diameter;
- Optional NEMA receptacle & photocell for energy saving.

TECHNICAL PARAMETERS

Input Voltage	100-277Vac	
Power	40W-400W	
Power Factor	0.95	
Available CCT	3000K/4000K/5000K/5700K	
LED Brand	Lumileds Luxeon 3030	Customized Lumileds 5050
Typical Luminous Efficacy	129lm/W @40W 126lm/W @50W 125lm/W @60W 135lm/W @80W/120W/160W 132lm/W @100W/150W/200W/300W 130lm/W @120W/180W/240W/360W 127lm/W @400W	150lm/W @40W 148lm/W @50W 146lm/W @60W/100W 157lm/W @80W/120W/160W 155lm/W @100W/150W/200W/300W 153lm/W @120W/180W/240W/360W 150lm/W @400W
Lighting Distribution	TYPE I TYPE II	TYPE I TYPE II TYPE III
	See lighting distribution options on appendix	
Working Temperature	-40~+50°C	
Installation Diameter	Ø40-50mm/ Ø55-65mm/ Ø65-75mm	

T67

LED STREET LIGHT



CE CB RoHS

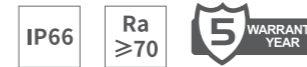

MAIN FEATURES

- Unique patented IP68 LED light engines;
- Two latches provide easy, tool-less access to the IP66 rated electrical compartment;
- Die-cast aluminum housing, solid mechanism and reliable quality;
- Ergonomic and dedicated lighting distributions for unmatched lighting performance;
- Fin-less whole structure heating dissipation design;
- Tempered glass for easy cleaning;
- Optional NEMA receptacle & photocell for energy saving.

TECHNICAL PARAMETERS

Input Voltage	100-277Vac	
Power	60W-240W	
Power Factor	0.95	
Available CCT	3000K/4000K/5000K/5700K	
LED Brand	Lumileds Luxeon 3030	Customized Lumileds 5050
Typical Luminous Efficacy	131lm/W @40W 128lm/W @50W 127lm/W @60W 138lm/W @80W/120W/160W 135lm/W @100W/150W/200W 133lm/W @120W/180W/240W	150lm/W @40W 148lm/W @50W 146lm/W @60W 157lm/W @80W/120W/160W 155lm/W @100W/150W/200W 153lm/W @120W/180W/240W
Lighting Distribution	TYPE II	TYPE I TYPE II TYPE III
	See lighting distribution options on appendix	
Working Temperature	-40~+50°C	
Installation Diameter	Ø40-50mm(non-standard)/Ø57-63mm	

T68 LED STREET LIGHT



■ MAIN FEATURES

- Unique patented IP68 LED light engines;
- Two latches provide easy, tool-less access to the IP66 rated electrical compartment;
- Die-cast aluminum housing, solid mechanism and reliable quality;
- Ergonomic and dedicated lighting distributions for unmatched lighting performance;
- Fin-less whole structure heating dissipation design;
- Post-top or side-entry installation with ±15° inclination, compatible with a wide range of pole diameter;
- Optional NEMA receptacle & photocell for energy saving.

CE CB RoHS

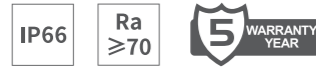

■ TECHNICAL PARAMETERS

Input Voltage	100-277Vac	
Power	40W-400W	
Power Factor	0.95	
Available CCT	3000K/4000K/5000K/5700K	
LED Brand	Lumileds Luxeon 3030	Customized Lumileds 5050
Typical Luminous Efficacy	145lm/W @40W 142lm/W @50W 140lm/W @60W 150lm/W @80W/120W/160W 147lm/W @100W/150W/200W/300W 145lm/W @120W/180W/240W/360W 141lm/W @400W	168lm/W @40W 165lm/W @50W 160lm/W @60W/100W 173lm/W @80W/120W/160W 170lm/W @100W/150W/200W/300W 167lm/W @120W/180W/240W/360W 170lm/W @400W
Lighting Distribution	TYPE I TYPE II	TYPE I TYPE II TYPE III
	See lighting distribution options on appendix	
Working Temperature	-40~+50°C	
Installation Diameter	Ø40-50mm/ Ø55-65mm/ Ø65-75mm	

T69 LED STREET LIGHT



■ MAIN FEATURES

- Unique patented IP68 LED light engines;
- Two latches provide easy, tool-less access to the IP66 rated electrical compartment;
- Die-cast aluminum housing, solid mechanism and reliable quality;
- Ergonomic and dedicated lighting distributions for unmatched lighting performance;
- Fin-less whole structure heating dissipation design;
- Optional NEMA receptacle & photocell for energy saving.

CE CB RoHS



■ TECHNICAL PARAMETERS

Input Voltage	100-277Vac	
Power	60W-240W	
Power Factor	0.95	
Available CCT	3000K/4000K/5000K/5700K	
LED Brand	Lumileds Luxeon 3030	Customized Lumileds 5050
Typical Luminous Efficacy	148lm/W @40W 145lm/W @50W 143lm/W @60W 154lm/W @80W/120W/160W 151lm/W @100W/150W/200W 149lm/W @120W/180W/240W	168lm/W @40W 165lm/W @50W 160lm/W @60W 173lm/W @80W/120W/160W 170lm/W @100W/150W/200W 167lm/W @120W/180W/240W
Lighting Distribution	TYPE II	TYPE I TYPE II TYPE III
	See lighting distribution options on appendix	
Working Temperature	-40~+50°C	
Installation Diameter	Ø40-50mm(non-standard)/Ø57-63mm	

**GL1A
GL1B** MODULAR LED
GARDEN LIGHT



MAIN FEATURES

- Unique patented IP68 LED light engines;
- Ergonomic and dedicated lighting distributions available for various roadway applications;
- Whole structure heating dissipation design with excellent thermal conduction, radiation and convection;
- Flexible to reach desired power selections by choosing appropriate light engines;
- Tool-free onsite replacements of light engines greatly reduce maintenance cost;
- Unmatched lighting performance, driver stability and desirable lifespan;
- Post top mounting Ø60~70 (mm).

TECHNICAL PARAMETERS

Input Voltage	100-277Vac			
Power Factor	0.95			
Available CCT	3000K/4000K/5000K/5700K			
Module Type	M16A-VC	M16A-VB		
LED Brand	Lumileds Luxeon 3030	Customized Lumileds 5050		
Photo				
Module Quantity	1			
Power	30W/40W/50W/60W			
Typical Luminous Efficacy	135lm/W @40W 130lm/W @50W 122lm/W @60W	168lm/W @40W 163lm/W @50W 155lm/W @60W		
LightingDistribution	TYPE I TYPE II TYPE III TYPE V See lighting distribution options on appendix			
Working Temperature	-40~+50°C			
Installation Diameter	Ø60-70mm			

GL2A MODULAR LED
GARDEN LIGHT

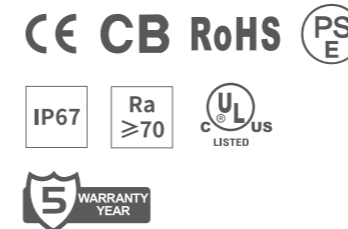

MAIN FEATURES

- Unique patented IP68 LED light engines;
- Ergonomic and dedicated lighting distributions available for various roadway applications;
- Whole structure heating dissipation design with excellent thermal conduction, radiation and convection;
- Flexible to reach desired power selections by choosing appropriate light engines;
- Tool-free onsite replacements of light engines greatly reduce maintenance cost;
- Unmatched lighting performance, driver stability and desirable lifespan;
- Post top mounting Ø60mm.

TECHNICAL PARAMETERS

Input Voltage	100-277Vac			
Power Factor	0.95			
Available CCT	3000K/4000K/5000K/5700K			
Module Type	M16A-VC	M16A-VB		
LED Brand	Lumileds Luxeon 3030	Customized Lumileds 5050		
Photo				
Module Quantity	2			
Power	80W 100W 120W			
Typical Luminous Efficacy	121lm/W @40W/Engine 117lm/W @50W/Engine 110lm/W @60W/Engine	152m/W @40W/Engine 146lm/W @50W/Engine 141lm/W @60W/Engine		
Lighting Distribution	TYPE I TYPE II TYPE III TYPE V See lighting distribution options on appendix			
Working Temperature	-40~+50°C			
Installation Diameter	Ø60-68mm			

TS21 LED TUNNEL LIGHT



CB CE RoHS



MAIN FEATURES

- Unique patented IP68 LED light engines;
- Ergonomic and dedicated lighting distributions available for various tunnel and underpass applications;
- Whole structure heating dissipation design with excellent thermal conduction and radiation;
- Unmatched lighting performance, driver stability and desirable lifespan;
- Bracket adjustable in ±60°, U-shaped bracket as an optional choice;
- Integrated die-casting whole structure cooling system, compact mechanism;
- Optional tempered glass over optical lens, easy for cleaning.

TECHNICAL PARAMETERS

Input Voltage	100-277Vac		
Power Factor	0.95		
Available CCT	3000K/4000K/5000K/5700K		
LED Brand	Lumileds Luxeon 3030		Customized Lumileds 5050
Lamp Model	TS21H	TS21M/C/D/E	
Power	20W-40W	40W-240W	
Typical Luminous Efficacy	117lm/W @20W 120lm/W @30W 122lm/W @40W	140lm/W @40W/Engine 135lm/W @50W/Engine 127lm/W @60W/Engine	175lm/W @40W/Engine 170lm/W @50W/Engine 163lm/W @60W/Engine
Lighting Distribution	TYPE I	TYPE I TYPE II Tunnel lighting	
	See lighting distribution options on appendix		
Working Temperature	-40~+50°C		

TS26 LINEAR LED TUNNEL LIGHT



CE RoHS

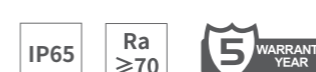

MAIN FEATURES

- Linear aluminum extrusion profile, could be applied in consecutive linear lighting for urban tunnels;
- IK07 rated tempered glass cover, easy for cleaning;
- Diffuse surface creates an anti-glare, gentle and even lighting effect;
- Specialized LEDs against automobile exhaust damage;
- L-shaped brackets adjustable in 60°;
- Power consumption could be customized.

TECHNICAL PARAMETERS

Input Voltage	100-240Vac
Power	20W-120W
Power Factor	0.95
Available CCT	3000K/4000K/5000K/5700K
Typical Luminous Efficacy	120lm/W
Lighting Distribution	Lambertian Type See lighting distribution options on appendix
Working Temperature	-40~+50°C
Body Length	100cm/ 120cm

TF2C LED HIGH BAY LIGHT

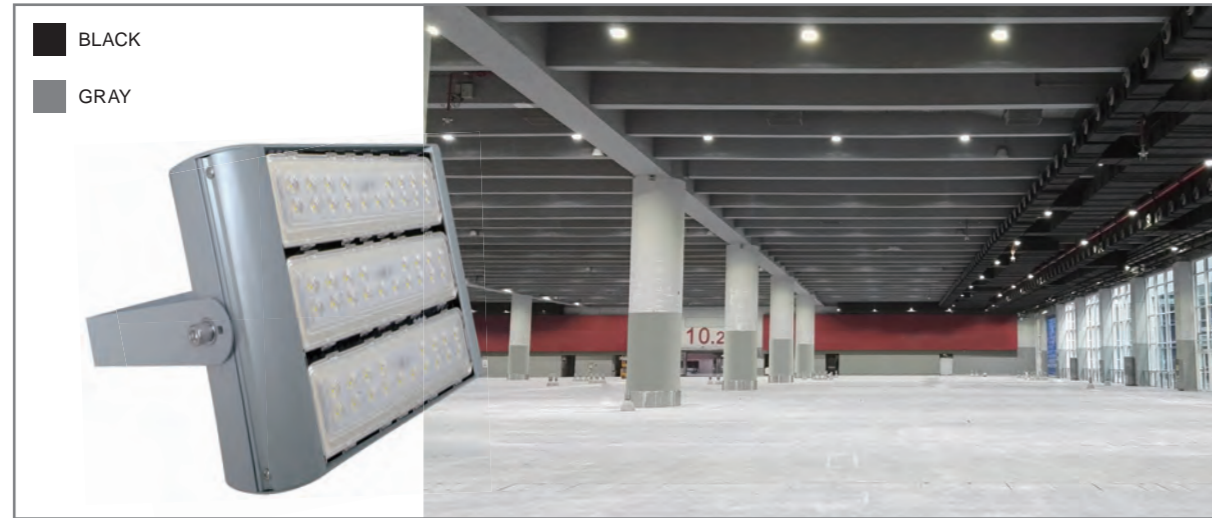

MAIN FEATURES

- Unique patented IP68 LED light engines;
- Ergonomic and dedicated lighting distributions available for warehouse, workshop, hall lighting, etc;
- Whole structure heating dissipation design with excellent thermal conduction, radiation and convection;
- Flexible to reach desired power selections by choosing appropriate light engines;
- Tool-free onsite replacements of light engines greatly reduce maintenance cost;
- Unmatched lighting performance, driver stability and desirable lifespan;
- Maximum 360° adjustable mounting brackets.

CE CB RoHS



TECHNICAL PARAMETERS

Input Voltage	100-277Vac							
Power Factor	0.95							
Available CCT	3000K/4000K/5000K/5700K							
Module Type	M16A-VC				M16A-VB			
LED Brand	Lumileds Luxeon 3030				Customized Lumileds 5050			
Photo								
Module Quantity	1	2	3	4	5	6	7	8
Power	40W 50W 60W	80W 100W 120W	120W 150W 180W	160W 200W 240W	200W 250W 300W	240W 300W 360W	280W 350W 420W	320W 400W 480W
Typical Luminous Efficacy	140lm/W @40W/Engine 135lm/W @50W/Engine 127lm/W @60W/Engine				175lm/W @40W/Engine 170lm/W @50W/Engine 163lm/W @60W/Engine			
Lighting Distribution	TYPE VS 12° 25° 40° 60° 90° 110° Lambert Type 40°x90° 90°x40° 110°x40° See lighting distribution options on appendix							
Working Temperature	-40~+50°C							

TF69A LED HIGH BAY LIGHT



MAIN FEATURES

- Unique patented IP68 LED light engines;
- Ergonomic and dedicated lighting distributions for unmatched lighting performance;
- Compact die-cast structure, solid mechanism and reliable quality;
- Tempered glass cover, easy for cleaning;
- Optional installation brackets for recessed mounting/ ceiling mounting/ surface mounting;
- Optional sensor for energy saving.

CE RoHS

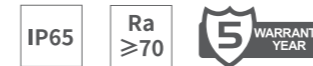

TECHNICAL PARAMETERS

Input Voltage	100-277Vac		
Power Factor	0.95		
Available CCT	3000K/4000K/5000K/5700K		
Power	80W-120W		
Mounting Style	Recessed Mounting 	Ceiling Mounting 	Surface Mounting
Model Name	TF69AQ	TF69AZ	TF69AX
Typical Luminous Efficacy	168lm/W @80W 164lm/W @100W 160lm/W @120W		
Lighting Distribution	110° See lighting distribution options on appendix		
Working Temperature	-40~+50°C		

FL2C MODULAR LED FLOOD LIGHT

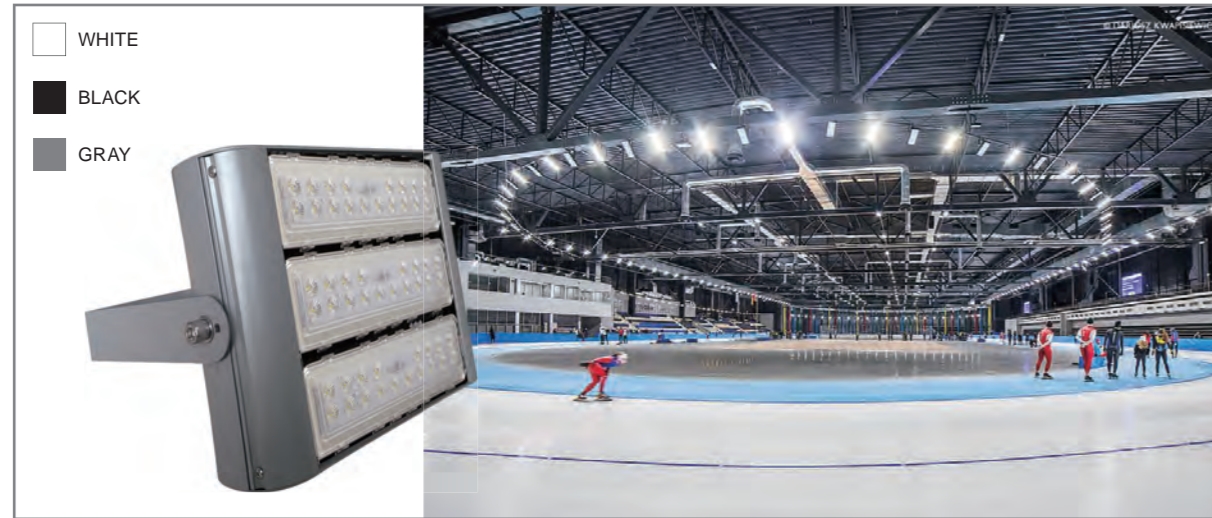

CE CB RoHS



MAIN FEATURES

- Unique patented IP68 LED light engines;
- Ergonomic and dedicated lighting distributions available for stadium, building and area lighting, etc;
- Whole structure heating dissipation design with excellent thermal conduction, radiation and convection;
- Flexible to reach desired power selections by choosing appropriate light engines;
- Tool-free onsite replacements of light engines greatly reduce maintenance cost;
- Effectively replaces HID products of 70-2000W.

TECHNICAL PARAMETERS

Input Voltage	100-277Vac											
Power Factor	0.95											
Available CCT	3000K/4000K/5000K/5700K											
Module Type	M16A-VC						M16A-VB					
LED Brand	Lumileds Luxeon 3030						Customized Lumileds 5050					
Photo												
Module Quantity	1	2	3	4	5	6	7	8	10	12	14	16
Power	40W 50W 60W	80W 100W 120W	120W 150W 180W	160W 200W 240W	200W 250W 300W	240W 300W 360W	280W 350W 420W	320W 400W 480W	400W 500W 600W	480W 600W 720W	560W 700W 840W	640W 800W 960W
Typical Luminous Efficacy	140lm/W @40W/Engine 135lm/W @50W/Engine 127lm/W @60W/Engine						175lm/W @40W/Engine 170lm/W @50W/Engine 163lm/W @60W/Engine					
Lighting Distribution	TYPE VS 12° 25° 40° 60° 90° 110° Lambert Type 45°x30° 80°x60° 90°x40° 110°x40° See lighting distribution options on appendix											
Working Temperature	-40~+50°C											

FL21 LED FLOOD LIGHT



CE CB RoHS

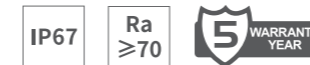

MAIN FEATURES

- Unique patented IP68 LED light engines;
- Ergonomic and dedicated lighting distributions for unmatched lighting performance;
- Compact die-cast structure, solid mechanism and reliable quality;
- Bracket adjustable in ±60°, L-shaped bracket as optional choice;
- Optional tempered glass cover over optical lens, easy for cleaning.

TECHNICAL PARAMETERS

Input Voltage	100-277Vac		
Power	30W-240W		
Power Factor	0.95		
Available CCT	3000K/4000K/5000K/5700K		
LED Brand	Lumileds Luxeon 3030		Customized Lumileds 5050
Typical Luminous Efficacy	FL21B	135lm/W @30W 130lm/W @40W 125lm/W @50W 117lm/W @60W	167lm/W @30W 163lm/W @40W 157lm/W @50W 150lm/W @60W
	FL21MC/DE	140lm/W @40W/Engine 135lm/W @50W/Engine 127lm/W @60W/Engine	175lm/W @40W/Engine 170lm/W @50W/Engine 163lm/W @60W/Engine
Lighting Distribution	25° 40° 60° 90° See lighting distribution options on appendix		
Working Temperature	-40~+50°C		

FL40 LED STADIUM LIGHT

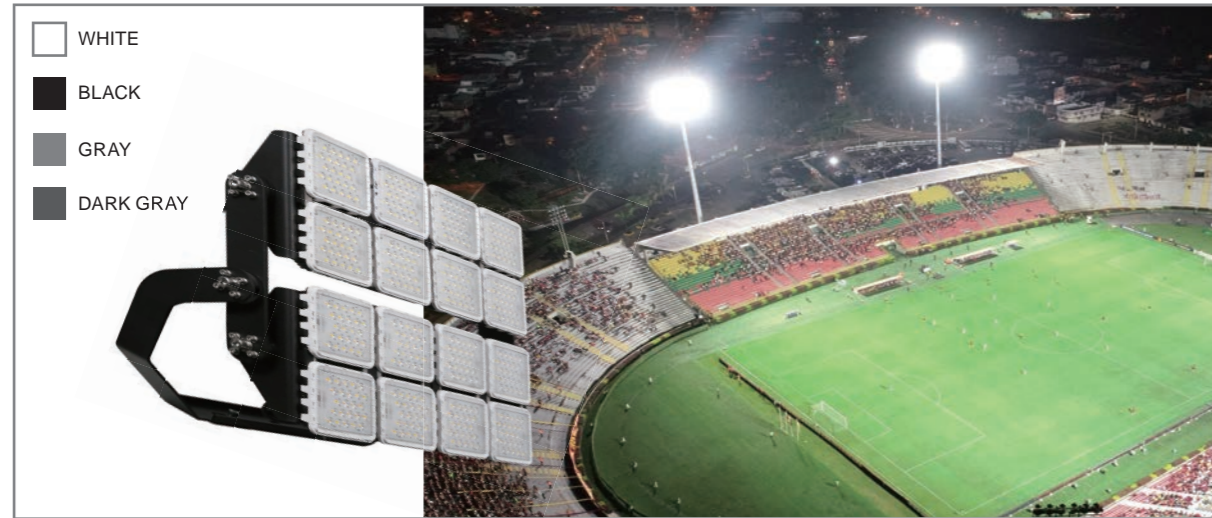

MAIN FEATURES

- Unique patented IP68 LED light engines;
- Full power range solutions up to 1500W;
- Professional lighting distributions for stadium applications, compatible with general flood lighting for various applications;
- Straightforward industrial design, compact mechanism and reliable quality;
- Bracket adjustable in +(-)45°~+75° with LED modules adjustable in -15°~+15° row by row for accurate lighting direction control;
- Whole structure heating dissipation design with excellent thermal conduction and radiation;
- Light shields available by option for each row of LED modules;
- Laser sight available by option for precise aiming;
- Steel rope available by option for safe mounting.

CE CB RoHS

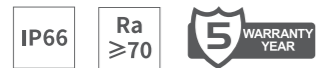

TECHNICAL PARAMETERS

Input Voltage	100-277Vac	
Power	300W-1500W	
Power Factor	0.95	
Available CCT	3000K/4000K/5000K/5700K	
LED Brand	Customized Lumileds 5050	Lumileds HL2X
Typical Luminous Efficacy	164lm/W @300W/600W/900W 157lm/W @400W/800W/1200W 150lm/W @500W/1000W/1500W	135lm/W @300W/600W/900W 130lm/W @400W/800W/1200W 125lm/W @500W/1000W/1500W
Lighting Distribution	25° 40° 60°	12° Sports lighting
Working Temperature	-40~+35°C	
	See lighting distribution options on appendix	

FL46 LED AIRPORT LIGHT



MAIN FEATURES

- Unique patented IP68 LED light engines;
- A new generation of modular technique, bigger lighting surface, higher efficiency;
- Flexible to reach desired power consumption up to 960W by combination of light engines;
- Ergonomic and specialized lighting distributions available for various area lighting applications;
- Narrow beam angle 10°/ 15° available for spot lighting and professional stadiums;
- Straightforward industrial design, solid mechanism and reliable quality;
- Whole structure heating dissipation design with excellent thermal conduction and radiation;
- Mounting bracket 360° adjustable.

CE CB RoHS



TECHNICAL PARAMETERS

Input Voltage	100-277Vac											
Power Factor	0.95											
Available CCT	3000K/4000K/5000K/5700K											
Module Quantity	1	2	3	4	5	6	7	8	10	12	14	16
Power	40W 50W 60W	80W 100W 120W	120W 150W 180W	160W 200W 240W	200W 250W 300W	240W 300W 360W	280W 350W 420W	320W 400W 480W	400W 500W 600W	480W 600W 720W	560W 700W 840W	640W 800W 960W
LED Brand	Lumileds HL2X				Lumileds Luxeon 3030				Customized Lumileds 5050			
Typical Luminous Efficacy	145lm/W @40W/Module 142lm/W @50W/Module 137lm/W @60W/Module				153lm/W @40W/Module 145lm/W @50W/Module 142lm/W @60W/Module				176lm/W @40W/Module 172lm/W @50W/Module 167lm/W @60W/Module			
Lighting Distribution	10° 15°				25° 40° 60° 90°				25° 40° 60° 90°			
Working Temperature	-40~+50°C											
	See lighting distribution options on appendix											

RK KEY PART SOLUTION



■ MAIN FEATURES

- Unique patented IP68 LED light engines;
- Ergonomic and dedicated lighting distributions available for various retrofit applications;
- Whole structure heating dissipation design with best thermal conduction, radiation and convection;
- Flexible to reach desired power selections by choosing appropriate light engines;
- Tool-free onsite replacements of light engines greatly reduce maintenance cost;
- Unmatched lighting performance, driver stability and desirable lifespan;
- Customizable sheet dimensions and finishing color.

CE RoHS



■ TECHNICAL PARAMETERS

Input Voltage	100-277Vac	
Power factor	0.95	
Available CCT	3000K/4000K/5000K/5700K	
Module Type	M16A-VC	M16A-VB
LED Brand	Lumileds Luxeon 3030	Customized Lumileds 5050
Photo		
Module Quantity	1,2,3...n	1,2,3...n
Power	n*40W/50W/60W	n*40W/50W/60W
Typical Luminous Efficacy	140lm/W @40W/Engine 135lm/W @50W/Engine 127lm/W @60W/Engine	175lm/W @40W/Engine 170lm/W @50W/Engine 163lm/W @60W/Engine
Lighting distribution	TYPE I TYPE II TYPE III TYPE V 25° 40° 60° 90° Lambert Type etc See lighting distribution options on appendix	
Working Temperature	-40~+50°C	

■ TRADITIONAL RETROFIT OPERATION GUIDE

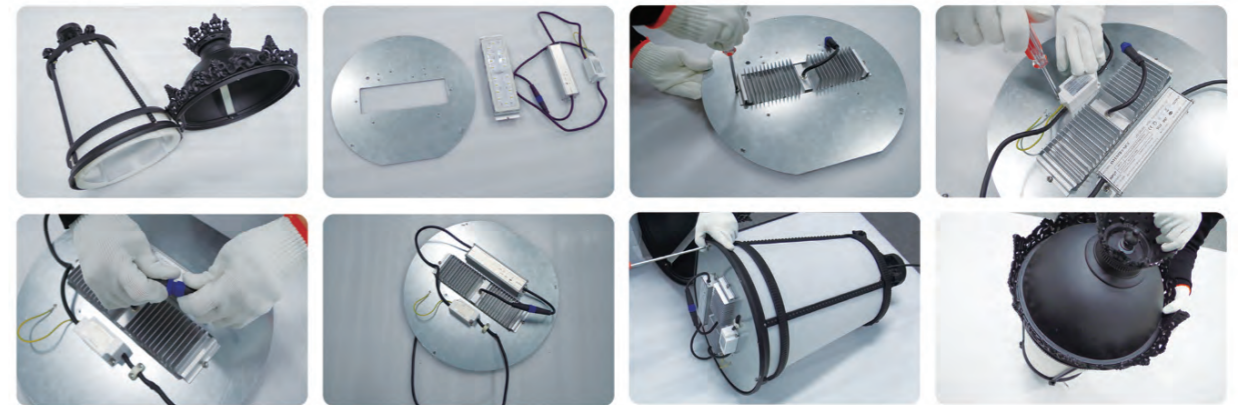

■ RETROFIT CASES

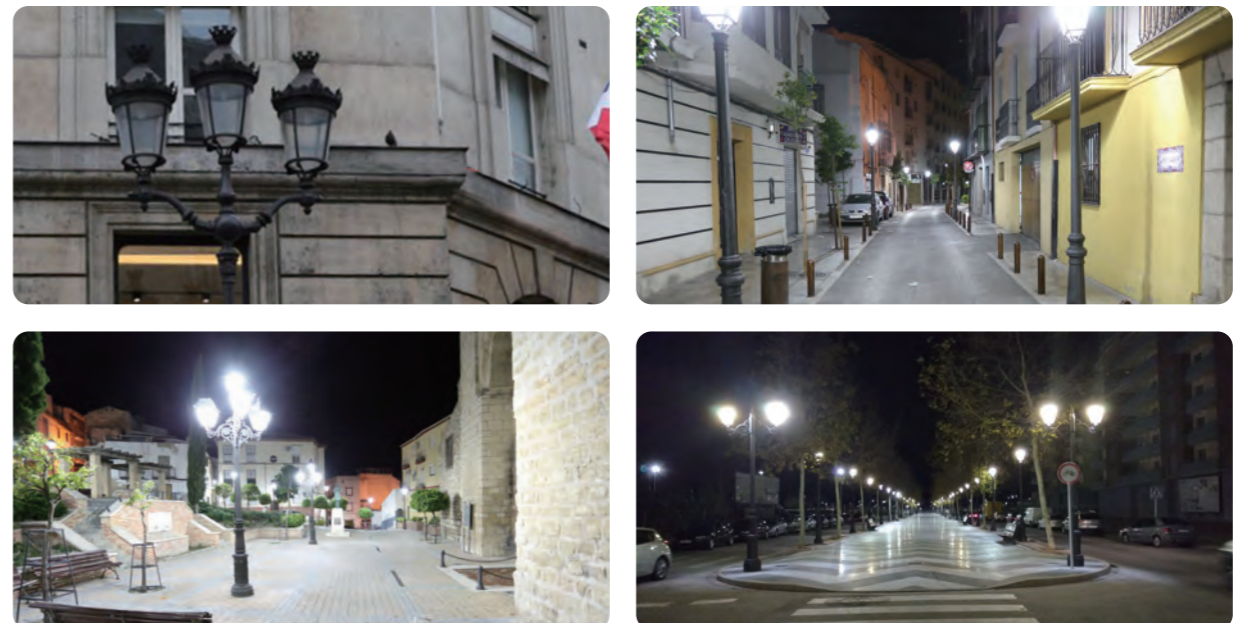

APPENDIX: LIGHTING DISTRIBUTION

ASYMMETRIC LIGHTING DISTRIBUTIONS

IESNA TYPE	TYPE I	TYPE II	TYPE III	TYPE V
CURVES				
M16A-VC	✓	✓	✓	✓
M16A-VB	✓	✓	✓	✓
CK16BMAX		✓		
T1M/T29A STREET LIGHT	✓	✓		
T1Q/T29B/T33 STREET LIGHT	✓	✓	✓	
T2Q/T33B	✓	✓		
T65/T68	✓	✓	✓	
T67/T69	✓	✓	✓	

SYMMETRIC LIGHTING DISTRIBUTIONS

BEAM ANGLE (50%)	12°	25°	40°	60°	90°	LAMBERTIAN
CURVES						
M16A-VC		✓	✓	✓	✓	✓
M16A-VB		✓	✓	✓	✓	✓
CK16BMAX		✓	✓	✓	✓	

SPECIAL LIGHTING DISTRIBUTION

APPLICATION	TUNNEL LIGHTING	SQUARE LIGHTING	BILLBOARD LIGHTING	SPORT LIGHTING	AISLE LIGHTING
CURVES					
M16A-VC	✓				
M16A-VB	✓	✓	✓	✓	✓
CK16BMAX				✓	

M66A-CC/VC MODULE ASYMMETRIC LIGHTING DISTRIBUTIONS

IESNA TYPE	T2M2510	T2M2523	T2M5512	T3M6513
TYPE II				
IESNA TYPE	25D6525	40D5540	60D6560	90D5590
TYPE II				

M66A-CB/VB MODULE ASYMMETRIC LIGHTING DISTRIBUTIONS

IESNA TYPE	T2S5531	T1S2530	T2M6532	T3M5533
TYPE II				
IESNA TYPE	25D6534	40D5535	60D6536	90D5537
TYPE II				

*More lighting distribution options are in development. Please contact sales for more information.

APPENDIX: LIGHTING DISTRIBUTION

M16A-VC MODULE ASYMMETRIC LIGHTING DISTRIBUTIONS



M16A-VC MODULE SYMMETRIC LIGHTING DISTRIBUTIONS

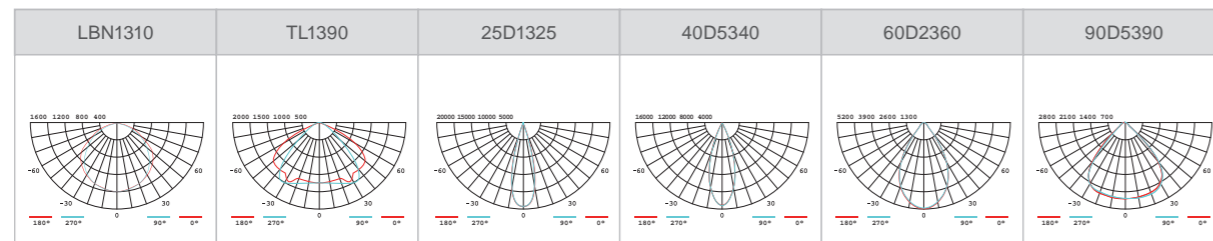

M16A-VC MODULE ASYMMETRIC LIGHTING DISTRIBUTIONS

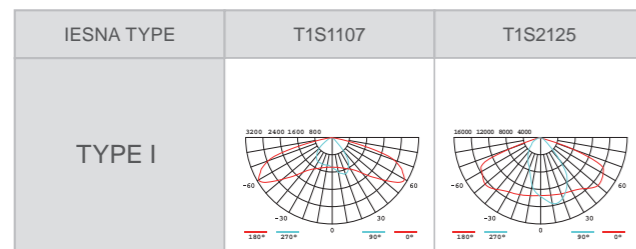

M16A-VB MODULE ASYMMETRIC LIGHTING DISTRIBUTIONS

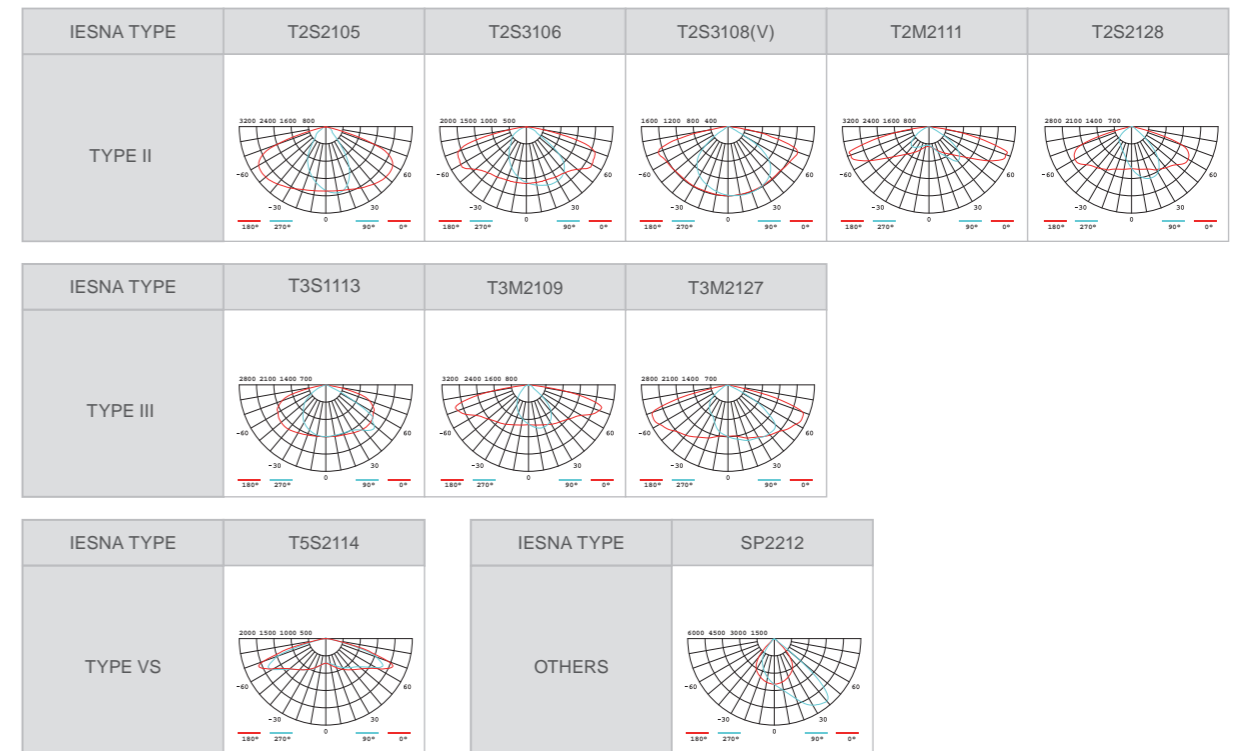

M16A-VB MODULE SYMMETRIC LIGHTING DISTRIBUTIONS

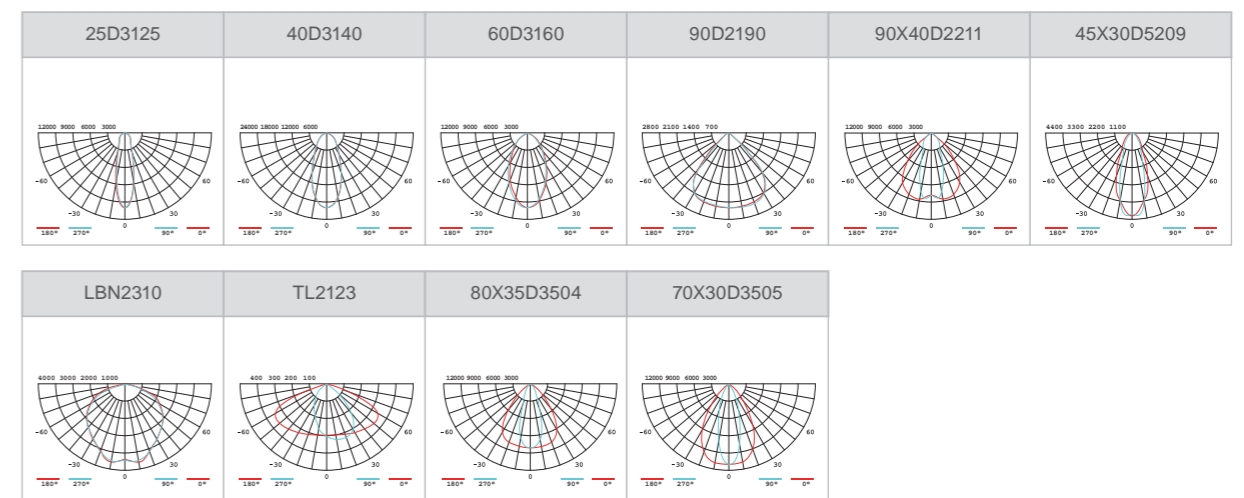

*More lighting distribution options are in development. Please contact sales for more information.

APPENDIX: LIGHTING DISTRIBUTION

T88 STREET LIGHT

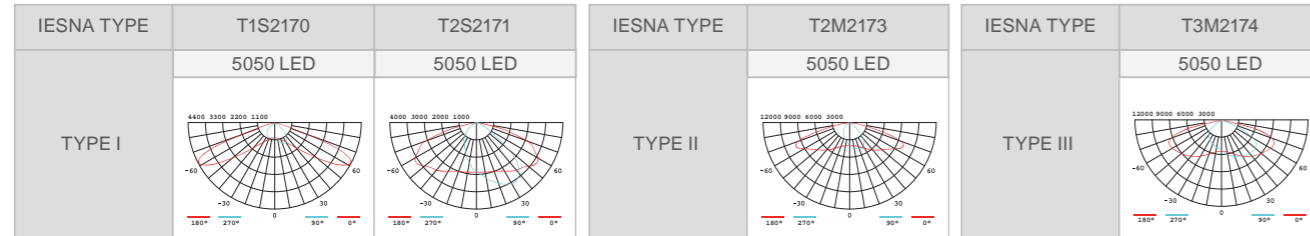

T1MAX STREET LIGHT

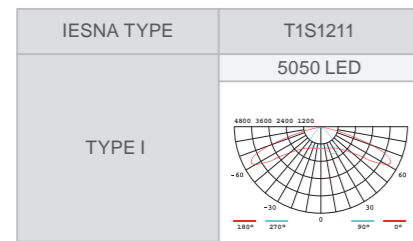

T1QMAX STREET LIGHT

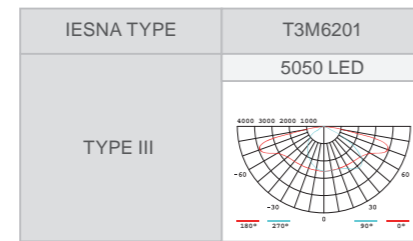

T2QMAX STREET LIGHT

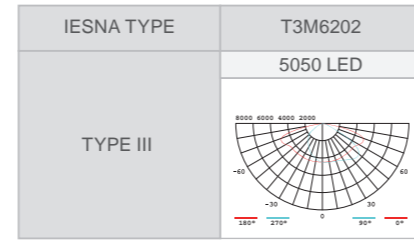

T29A STREET LIGHT

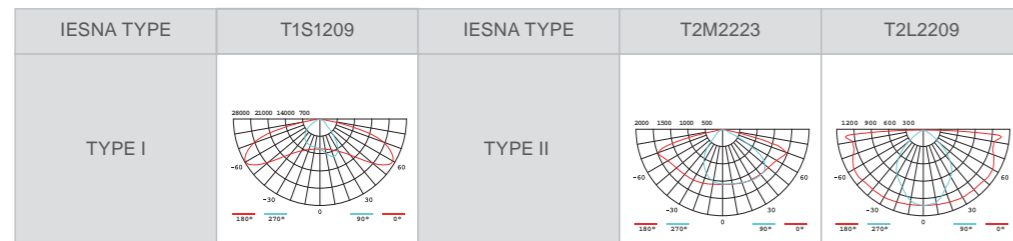

T29B/T28D/T33A/ STREET LIGHT

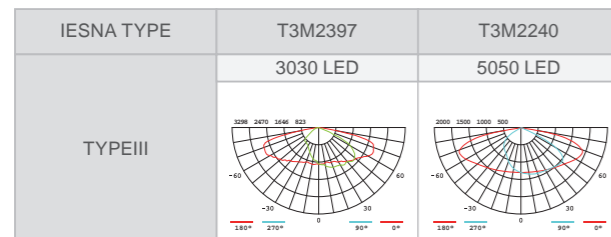
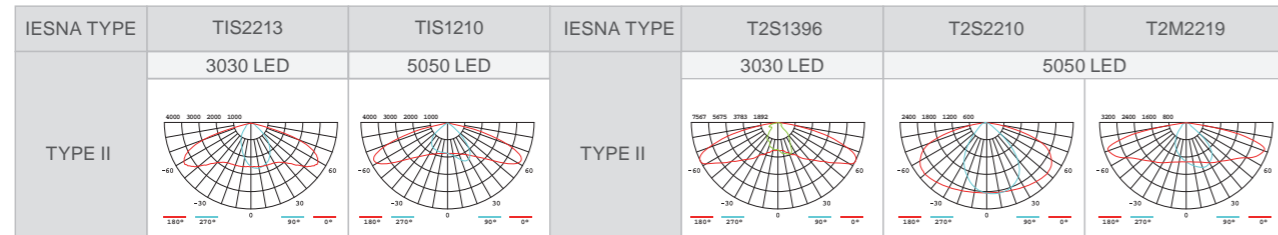

T2Q/T33B STREET LIGHT

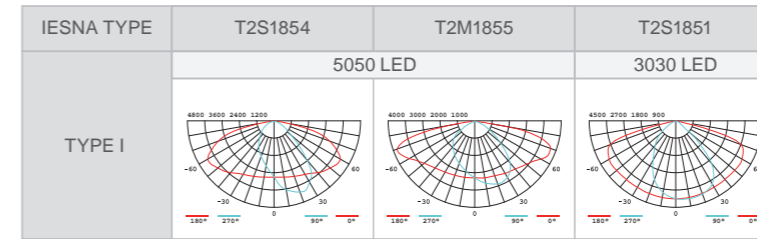
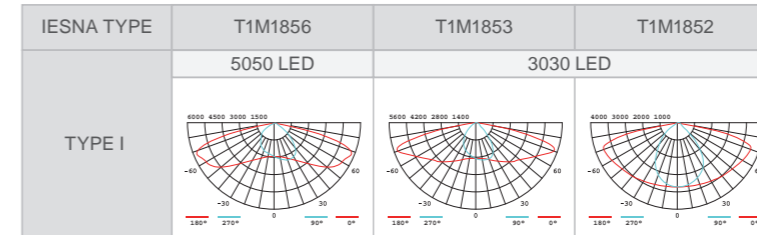

T29C/ T33CDE STREET LIGHT

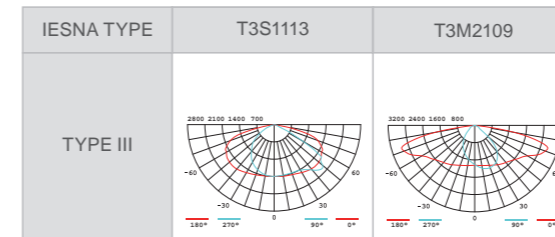
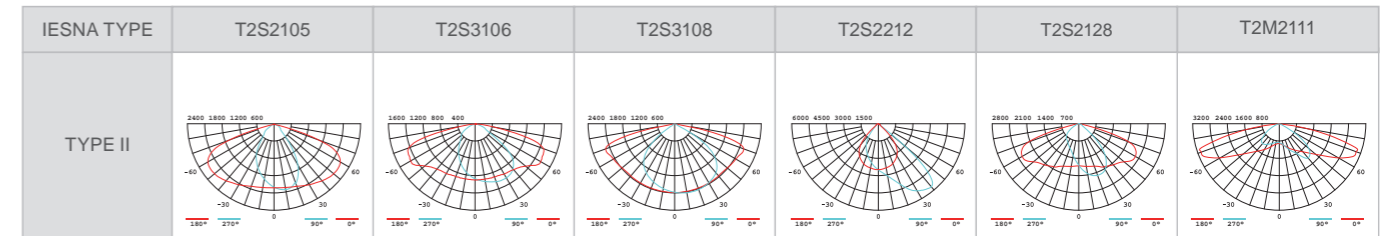
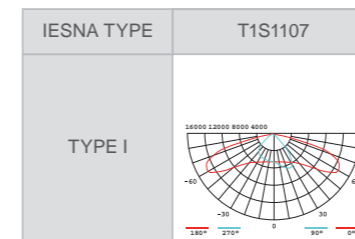

*More lighting distribution options are in development. Please contact sales for more information.

APPENDIX: LIGHTING DISTRIBUTION

T65/T68 STREET LIGHT

IESNA TYPE	T1S1881/T1S1884	IESNA TYPE	T2S1882/T2S1885	IESNA TYPE	T3S2883/T3S2886	IESNA TYPE	T2S1846 (ONLY T65N1-100)
	5050 LED		5050 LED		5050 LED		5050 LED
TYPE I		TYPE II		TYPE III		TYPE III	
IESNA TYPE	T1S1891/T1S1894	IESNA TYPE	T2M1892/T2M1895	IESNA TYPE	T2S2893/T2S2996		
	3030 LED		3030 LED		3030 LED		
TYPE I		TYPE II		TYPE III			

T67/T69 STREET LIGHT

IESNA TYPE	T1S1384/T1S1385	IESNA TYPE	T2S2386	IESNA TYPE	T3M2387
	5050 LED		5050 LED		5050 LED
TYPE I		TYPE II		TYPE III	
IESNA TYPE	T2M1581/T2M1582				
	3030 LED				
TYPE I					

APPENDIX: ORDERING INFORMATION

MODULE ORDERING INFORMATION

EXAMPLE: M16A-VCH[H]-63-1324-7040-LU

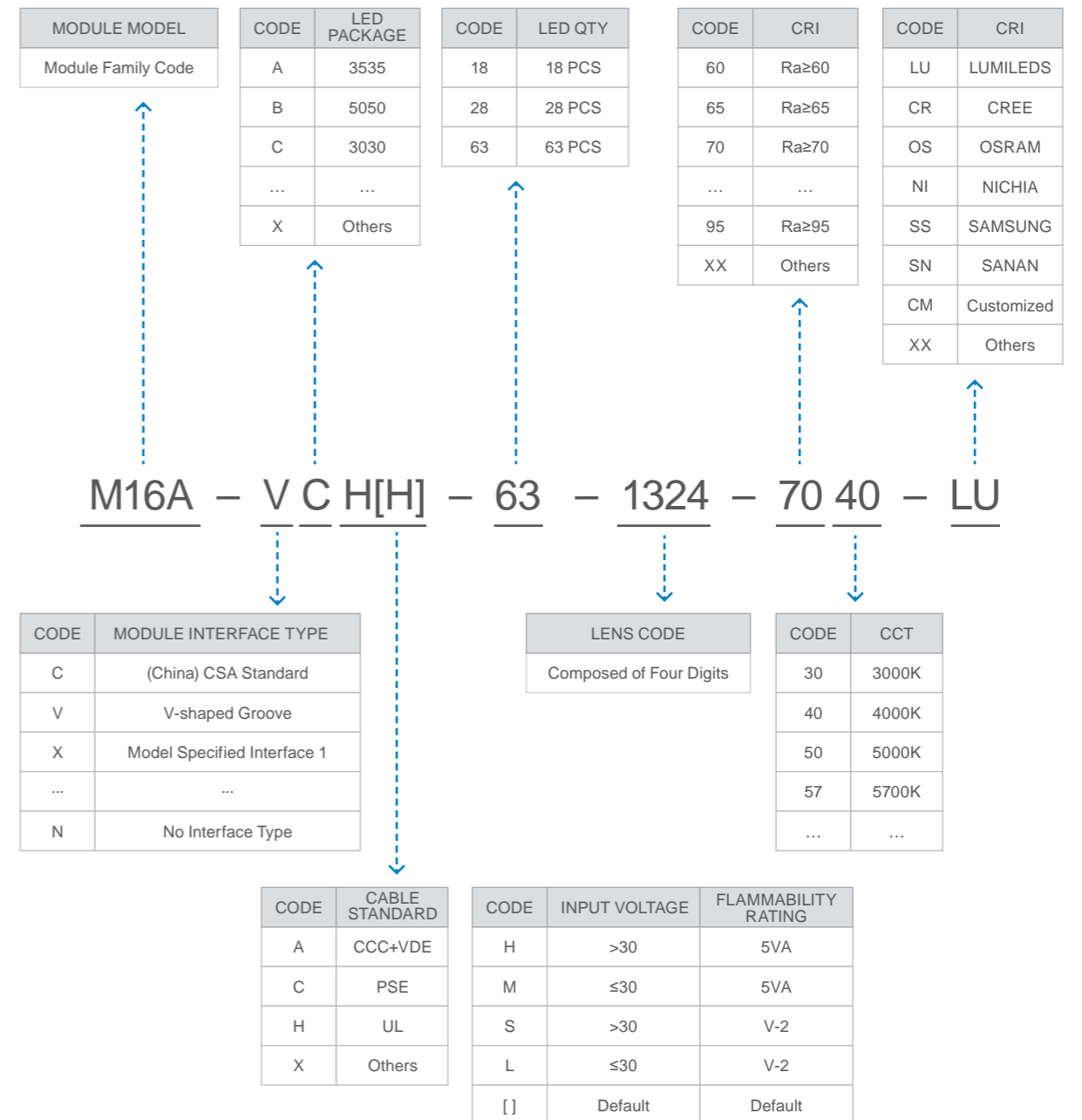

*Applicable premise: H, i.e. CABLE STANDARD being UL. Otherwise, default.

APPENDIX: ORDERING INFORMATION

LUMINAIRE ORDERING INFORMATION

EXAMPLE: T11A-3[B]-180[P]-M1A--18-1501-7040-LU-MW[T]-WH[B]-[CN]

